

User Manual



WCA230A & WCA280A Option 40 3GPP Release 6 (HSUPA) Analysis Software

071-2062-00

This document supports firmware version 3.30 and above.

www.tektronix.com

Copyright © Tektronix, Inc. All rights reserved. Licensed software products are owned by Tektronix or its subsidiaries or suppliers, and are protected by national copyright laws and international treaty provisions.

Tektronix products are covered by U.S. and foreign patents, issued and pending. Information in this publication supercedes that in all previously published material. Specifications and price change privileges reserved.

TEKTRONIX and TEK are registered trademarks of Tektronix, Inc.

Contacting Tektronix

Tektronix, Inc.
14200 SW Karl Braun Drive
P.O. Box 500
Beaverton, OR 97077
USA

For product information, sales, service, and technical support:

- In North America, call 1-800-833-9200.
- Worldwide, visit www.tektronix.com to find contacts in your area.

Warranty 2

Tektronix warrants that this product will be free from defects in materials and workmanship for a period of one (1) year from the date of shipment. If any such product proves defective during this warranty period, Tektronix, at its option, either will repair the defective product without charge for parts and labor, or will provide a replacement in exchange for the defective product. Parts, modules and replacement products used by Tektronix for warranty work may be new or reconditioned to like new performance. All replaced parts, modules and products become the property of Tektronix.

In order to obtain service under this warranty, Customer must notify Tektronix of the defect before the expiration of the warranty period and make suitable arrangements for the performance of service. Customer shall be responsible for packaging and shipping the defective product to the service center designated by Tektronix, with shipping charges prepaid. Tektronix shall pay for the return of the product to Customer if the shipment is to a location within the country in which the Tektronix service center is located. Customer shall be responsible for paying all shipping charges, duties, taxes, and any other charges for products returned to any other locations.

This warranty shall not apply to any defect, failure or damage caused by improper use or improper or inadequate maintenance and care. Tektronix shall not be obligated to furnish service under this warranty a) to repair damage resulting from attempts by personnel other than Tektronix representatives to install, repair or service the product; b) to repair damage resulting from improper use or connection to incompatible equipment; c) to repair any damage or malfunction caused by the use of non-Tektronix supplies; or d) to service a product that has been modified or integrated with other products when the effect of such modification or integration increases the time or difficulty of servicing the product.

THIS WARRANTY IS GIVEN BY TEKTRONIX WITH RESPECT TO THE PRODUCT IN LIEU OF ANY OTHER WARRANTIES, EXPRESS OR IMPLIED. TEKTRONIX AND ITS VENDORS DISCLAIM ANY IMPLIED WARRANTIES OF MERCHANTABILITY OR FITNESS FOR A PARTICULAR PURPOSE. TEKTRONIX' RESPONSIBILITY TO REPAIR OR REPLACE DEFECTIVE PRODUCTS IS THE SOLE AND EXCLUSIVE REMEDY PROVIDED TO THE CUSTOMER FOR BREACH OF THIS WARRANTY. TEKTRONIX AND ITS VENDORS WILL NOT BE LIABLE FOR ANY INDIRECT, SPECIAL, INCIDENTAL, OR CONSEQUENTIAL DAMAGES IRRESPECTIVE OF WHETHER TEKTRONIX OR THE VENDOR HAS ADVANCE NOTICE OF THE POSSIBILITY OF SUCH DAMAGES.

Table of Contents

Preface	v
About This Manual	v
Related Manuals	v

Getting Started

Getting Started	1-1
Analysis Definition	1-2
Measurement Menu	1-5

Operating Basics

Downlink Analysis	2-1
Measurement Procedure	2-2
Measurement Setup Menu	2-5
Scale and Format of View	2-8
Code Domain Power	2-12
Power Codogram	2-14
Code Power versus Time Slot	2-16
Code Power versus Symbol	2-18
Symbol Constellation	2-20
Symbol EVM	2-21
Symbol Eye Diagram	2-23
Symbol Table	2-24
Modulation Accuracy	2-25
Modulation Accuracy versus Time Slot	2-26
Uplink Analysis	2-29
Measurement Procedure	2-30
Measurement Setup Menu	2-32
Display Method for HS-DPCCH	2-36
Scale and Format of View	2-39
Code Domain Power	2-44
Power Codogram	2-46
Code Power versus Time Slot	2-48
Code Power versus Symbol	2-50
Symbol Constellation	2-52
Symbol EVM	2-53
Symbol Eye Diagram	2-55
Symbol Table	2-56
Modulation Accuracy	2-57
Modulation Accuracy versus Time Slot	2-59
Gain Ratio	2-61

Syntax and Commands

Command Groups	3-1
Functional Groups	3-1
:CONFigure Commands	3-2
:DISPlay Commands	3-2
:FETCh Commands	3-4
:MMEMory Commands	3-4
:SENSe Commands	3-4
:CONFigure Commands	3-7
:DISPlay Commands	3-9
::FETCh Commands	3-55
:MMEMory Commands	3-69
:SENSe Commands	3-77

Appendices

Appendix A: Scale Setting Range	A-1
Appendix B: Saving Measurement Results	B-1
Save Menu	B-1
Saved File Format	B-2
Appendix C: Factory Default Settings	C-1

Glossary and Index

List of Figures

Figure 1-1: Measurement menus for the 3GPP-R6 analysis	1-5
Figure 2-1: Downlink analysis measurement menu in the Demod mode	2-1
Figure 2-2: Code domain power measurement example	2-4
Figure 2-3: Time slot table (at the lower left of the screen)	2-11
Figure 2-4: Code domain power	2-12
Figure 2-5: Power codogram	2-14
Figure 2-6: Code power versus Time slot	2-16
Figure 2-7: Code domain power versus Symbol	2-18
Figure 2-8: Symbol constellation	2-20
Figure 2-9: Symbol EVM	2-21
Figure 2-10: Symbol eye diagram	2-23
Figure 2-11: Symbol table	2-24
Figure 2-12: Modulation accuracy	2-25
Figure 2-13: Modulation accuracy versus Time slot, EVM (rms)	2-26
Figure 2-14: Uplink analysis measurement menu in the Demod mode	2-29
Figure 2-15: Code domain power measurement example	2-31
Figure 2-16: Subframe offset	2-34
Figure 2-17: HS-DPCCH display method	2-36
Figure 2-18: HS-DPCCH display method	2-37
Figure 2-19: HS-DPCCH display method (symbol table)	2-38
Figure 2-20: View Format setting (code domain power)	2-42
Figure 2-21: Time slot table (at the lower left of the screen)	2-43
Figure 2-22: Code domain power	2-44
Figure 2-23: Power codogram	2-46
Figure 2-24: Code power versus Time slot	2-48
Figure 2-25: Code domain power versus Symbol	2-50
Figure 2-26: Symbol constellation	2-52
Figure 2-27: Symbol EVM	2-53
Figure 2-28: Symbol eye diagram	2-55
Figure 2-29: Symbol table	2-56
Figure 2-30: Modulation accuracy	2-57
Figure 2-31: Modulation accuracy versus Time slot, EVM (rms)	2-59
Figure 2-32: Gain ratio	2-61
Figure B-1: Setting the time slots to save	B-2
Figure B-2: CSV file example (code domain power measurement)	B-2

List of Tables

Table 1-1: Additional functions in Option 40	1-1
Table 1-2: 3GPP-R6 downlink transmission parameters	1-2
Table 1-3: 3GPP-R6 uplink transmission parameters	1-3
Table 2-1: Column items	2-11
Table 2-2: Vertical scale setting range, Symbol EVM	2-22
Table 2-3: Vertical scale setting range, Modulation accuracy versus Time slot	2-27
Table 2-4: Channel number	2-42
Table 2-5: Time-slot table contents selection	2-43
Table 2-6: Vertical scale setting range, Symbol EVM	2-54
Table 2-7: Vertical scale setting range, Modulation accuracy versus Time slot	2-60
Table 3-1: Measurement modes added in Option 40	3-1
Table 3-2: List of command groups	3-1
Table 3-3: :CONFigure commands	3-2
Table 3-4: :DISPlay commands	3-2
Table 3-5: :FETCh commands	3-4
Table 3-6: :MMEMory commands	3-4
Table 3-7: :SENSE commands	3-4
Table 3-8: :DISPlay command subgroups	3-9
Table 3-9: Symbol rate settings, downlink	3-18
Table 3-10: Downlink display formats	3-22
Table 3-11: Symbol rate settings, uplink	3-40
Table 3-12: Uplink display formats	3-44
Table 3-13: Queried information on the 3GPP-R6 downlink analysis results ..	3-56
Table 3-14: Queried information on the 3GPP-R6 uplink analysis results	3-61
Table 3-15: Item to save	3-71
Table 3-16: Content to save	3-72
Table 3-17: :SENSE command subgroups	3-77
Table 3-18: Configuration in 3GPP-R6	3-94
Table 3-19: DPCCH format	3-95
Table A-1: Display format and scale	A-1
Table C-1: Factory initialization settings, :DISPlay commands	C-1
Table C-2: Factory initialization settings, :SENSE commands	C-2

Preface

This manual provides operating instructions for the WCA230A and WCA280A Portable Wireless Communication Analyzers Option 40 3GPP Release 6 (HSUPA) analysis software.

About This Manual

This manual is composed of the following sections:

- *Getting Started* describes the overview of the 3GPP Release 6 analysis.
- *Operating Basics* explains the menu functions and measurement procedures.
- *Syntax and Commands* describes GPIB commands for Option 27.
- *Appendix* provides additional information including factory default settings and scale setting range.

Related Manuals

The following related documents are also available:

- The *WCA230A & WCA280A Portable Wireless Communication Analyzers User Manual* (Tektronix part number 071-1253-xx) contains a tutorial to quickly describe how to operate the analyzer. It also includes an in-depth discussion on how to more completely use the analyzer features.
- The *WCA230A & WCA280A Portable Wireless Communication Analyzer Programmer Manual* (Tektronix part number 071-1255-xx) contains an alphabetical listing of the programming commands and other information related to controlling the analyzer over the GPIB interface.



Getting Started

Getting Started

The WCA230A and WCA280A Option 40 3GPP Release 6 (HSUPA) analysis software enables modulation analysis of HSUPA (High Speed Uplink Packet Access) signals defined in 3GPP (3rd Generation Partnership Project) Release 6 (“3GPP-R6”). Measurements can be performed on downlink QPSK and 16QAM or uplink BPSK signals.

Table 1-1 summarizes the functions added in Option 40 by the measurement modes of the analyzer.

Table 1-1: Additional functions in Option 40

Measurement mode	Additional functions	Requirement
S/A (spectrum analysis)	None	-
Demod (modulation analysis)	3GPP-R6 downlink analysis <ul style="list-style-type: none"> ■ Code domain power ■ Power codogram ■ Code power versus Time slot ■ Code power versus Symbol ■ EVM versus Time slot ■ Symbol constellation ■ Symbol EVM (Error Vector Magnitude) ■ Symbol eye diagram ■ Symbol table ■ Modulation accuracy ■ Modulation accuracy versus Time slot 	Option 27 3GPP-R5 analysis software
	3GPP-R6 uplink analysis <ul style="list-style-type: none"> ■ Code domain power ■ Power codogram ■ Code power versus Time slot ■ Code power versus Symbol ■ EVM versus Time slot ■ Symbol constellation ■ Symbol EVM (Error Vector Magnitude) ■ Symbol eye diagram ■ Symbol table ■ Modulation accuracy ■ Modulation accuracy versus Time slot ■ Gain ratio 	Option 23 W-CDMA uplink analysis software and Option 27 3GPP-R5 analysis software
Time (time analysis)	None	-

NOTE. Option 40 3GPP-R6 analysis software requires Option 23 W-CDMA uplink (for uplink analysis only) and Option 27 3GPP-R5 analysis software as shown in Table 1-1.

Analysis Definition

The analyzer performs measurements according to 3GPP-R6 specifications.

Downlink Analysis

Table 1-2 shows the 3GPP-R6 downlink transmission parameters for the analyzer.

Table 1-2: 3GPP-R6 downlink transmission parameters

Item	Description
Chip rate	3.84 Mcps
Symbol rate	7.5, 15, 30, 60, 120, 240, 480, and 960 ksps
Maximum number of channels	512
Frame structure	Time slot: 666.7 μ s
Scrambling code	Gold code using M series by generator polynomial 18 bits
Channelization code	Hierarchical orthogonal code series based on the combination of chip rate and symbol rate
Modulation method for each channel	QPSK or 16QAM
Baseband filter	Root-cosine with $\alpha = 0.22$ (default) Can be set in the range of $0.0001 \leq \alpha \leq 1$

Measurement Functions. The analyzer has the following measurement functions:

- *Code domain power:* Measures the power relative to the total power for each channel. Multi-rate is supported and up to 512 channels can be measured.
- *Code domain power versus Time:* Measures the relative power at symbol points for each channel in time series.
- *Power codogram:* Measures the code domain power and displays a spectrogram for each slot.
- *Vector/Constellation:* Measures the vector loci and chip points for all signals as well as constellation at symbol points for each channel.
- *Modulation accuracy:* Measures EVM (Error Vector Magnitude), amplitude and phase errors, waveform quality, and origin offset for each channel. Measures PCDE (Peak Code Domain Error), amplitude, frequency, and phase errors; waveform quality; and origin offset for each time slot.

Measurement Process. The following steps show the internal process for the 3GPP-R6 downlink analysis:

1. Perform flatness correction and filtering.
2. Establish the synchronization with P-SCH.
3. Determine the range of scrambling code numbers with S-SCH.
4. Fix the scrambling code number and the phase.
5. Correct the frequency and the phase.
6. Perform high-speed Hadamard transformation.
7. Calculate the power for each symbol on all channels.

Uplink Analysis The analyzer supports the following types of 3GPP-R6 uplink signals:

- DPCCH (Dedicated Physical Control Channel)
- DPDCH (Dedicated Physical Data Channel)
- HS-DPCCH (Dedicated Physical Control Channel for HS-DSCH (High Speed Downlink Shared Channel))
- E-DPCCH (Enhanced Dedicated Physical Control Channel)
- E-DPDCH (Enhanced Dedicated Physical Data Channel)

The analyzer covers the 3GPP-R6 uplink transmission parameters listed in Table 1-3.

Table 1-3: 3GPP-R6 uplink transmission parameters

Item	DPCCH	DPDCH	HS-DPCCH	E-DPCCH	E-DPDCH
Chip rate	3.84 Mcps				
Symbol rate	15 ksps	15, 30, 60, 120, 240, 480, and 960 ksps	15 ksps	15 ksps	15, 30, 60, 120, 240, 480, 960, and 1920 ksps
Maximum number of channels	1	6	1	1	4
Frame structure	15 time-slots, 10 ms	15 time-slots, 10 ms	5 sub-frames, 10 ms	5 sub-frames, 10 ms	15 time-slots, 10 ms
Time slot	2560 chips, 667 μ s				
Scrambling code	Long or short. Number: 0 to 16,777,215				
Modulation method	BPSK				
Baseband filter	Root-cosine with $\alpha = 0.22$ (default). Can be set in the range of $0.0001 \leq \alpha \leq 1$				

Measurement Functions. The analyzer has the following measurement functions:

- *HS-DPCCH analysis:* Measures the HS-DPCCH to detect and display the ACK/NACK/PRE/POST indicator, DTX (Discontinuous Transmission), and CQI (Channel Quality Indicator).
- *E-DPCCH analysis:* Measures the E-DPCCH to detect and display the E-TFC (E-DCH Transport Format Combination) indicator, RSN (Retransmission Sequence Number), and Happy.
- *Code domain power:* Measures the power relative to the total power for each channel. Multi-rate is supported and up to 512 channels can be measured.
- *Power codogram:* Measures the code domain power continuously for up to 150 slots (0.1 sec) and displays spectrogram for each slot.

NOTE. *The code domain power and the power codogram can be displayed in the subview only.*

Measurement Process. The following steps show the internal process for the 3GPP-R6 uplink analysis:

1. Perform flatness correction and filtering.
2. Search for a synchronous point by de-spreading DPCCH.
3. Correct the frequency and phase.
4. Obtain symbols for each channel of DPDCH and DPCCH, and calculate power for each symbol.

NOTE. *The analyzer de-spreads DPCCH and the control part of an input signal, using the frequency and phase to establish synchronization. If the level of DPCCH or the control part is much lower than (about $1/10^{\text{th}}$) the level of the other channels (DPDCH or the data part), the analysis may not be performed accurately.*

Measurement Menu

Figure 1-1 shows the measurement menus related to the 3GPP-R6 analysis. The menu items boxed with solid lines indicate the functions included in Option 40.

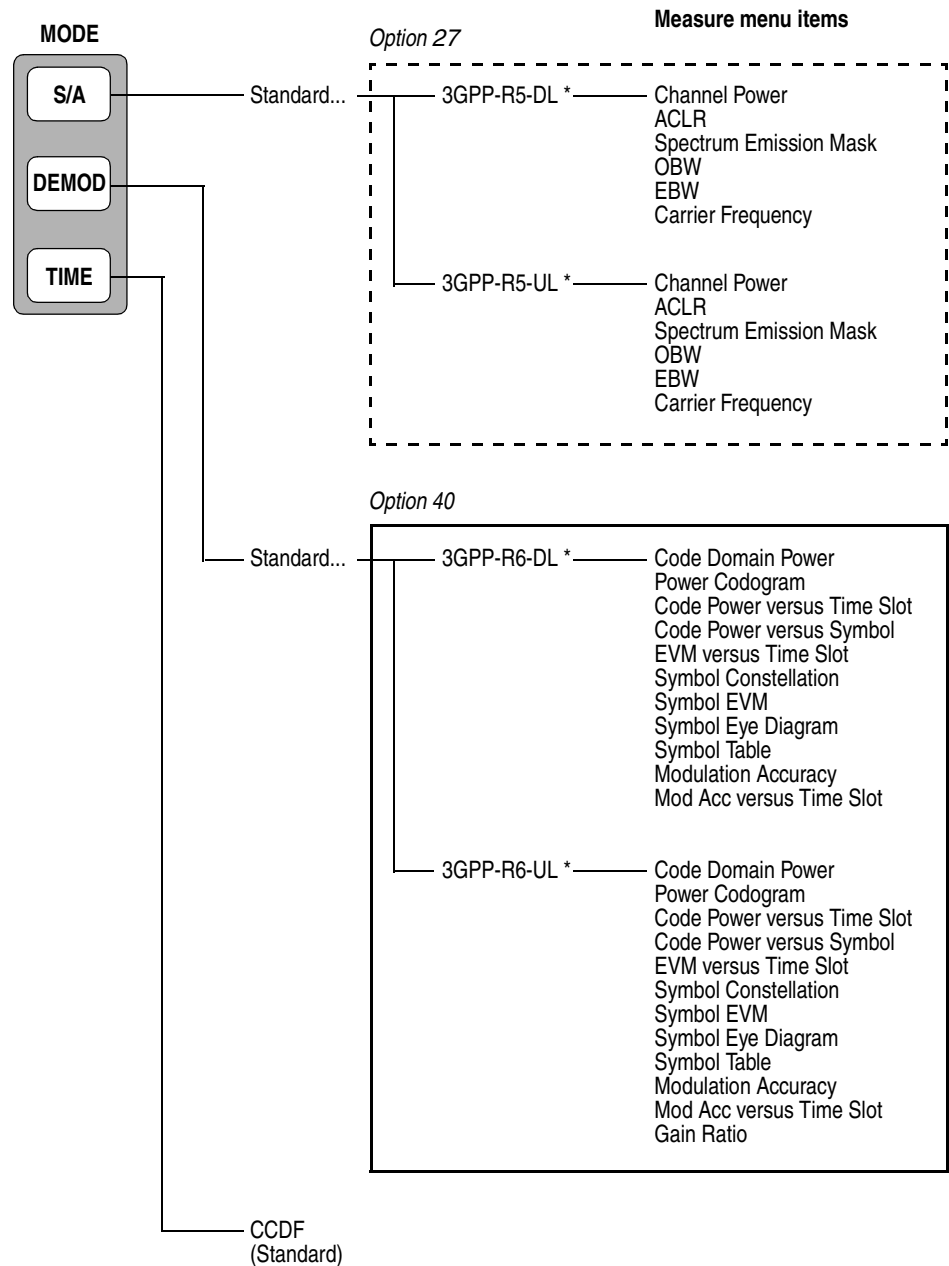

* DL and UL represent downlink and uplink, respectively.

Figure 1-1: Measurement menus for the 3GPP-R6 analysis

NOTE. *Option 40 performs only modulation analysis in the Demod mode. For spectrum analysis in the S/A mode, use Option 27 (3GPP-R5 analysis software).*

The following sections detail the measurement functions included in Option 40 which are indicated in the two boxes in Figure 1-1. For details on the other measurements, refer to the following user manuals:

- For the 3GPP-R5 analysis in the S/A mode, refer to the *WCA230A and WCA280A Option 27 3GPP Release 5 Downlink (HSDPA) Analysis Software User Manual* (Tektronix part number 071-1681-XX).
- For the CCDF (Complementary Cumulative Distribution Function) analysis in the Time mode, refer to the *WCA230A and WCA280A User Manual* (Tektronix part number 071-1617-XX).

NOTE. *If you are not familiar with the operation of the analyzer, refer to the WCA230A and WCA280A User Manual (Tektronix part number 071-1617-XX).*



Operating Basics

Downlink Analysis

This section describes the basic operation of the 3GPP-R6 downlink analysis in the Demod (Modulation Analysis) mode. You can access the measurement items by pressing **DEMOD** → **Standard...** → **3GPP-R6-DL** as shown in Figure 2-1.

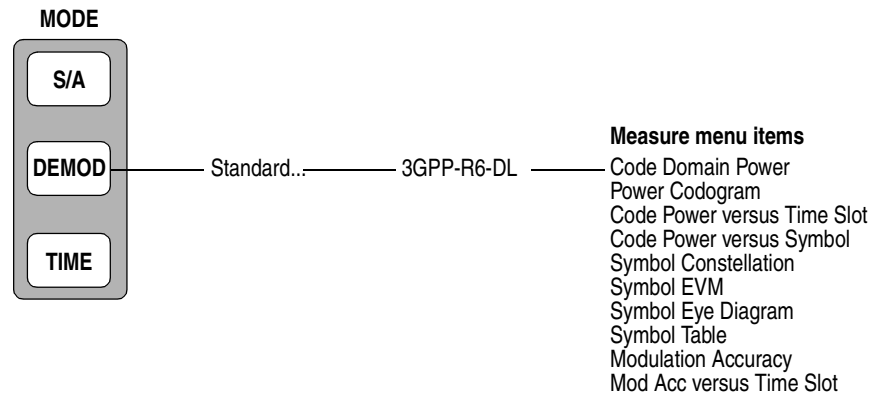

Figure 2-1: Downlink analysis measurement menu in the Demod mode

The measurement in the Demod mode is based on the digital modulation analysis function. For the digital modulation analysis, refer to the *WCA230A and WCA280A User Manual*.

Transmission Diversity. This software performs analysis synchronizing with CPICH of the STTD antenna 1 or 2 automatically, but does not apply decode (symbol replacement and inversion).

Measurement Procedure

The following procedure shows you how to acquire data of multiple slots in advance, measure continuous data, and obtain continuous code domain power:

NOTE. For details on setting frequency, span, and amplitude, refer to the WCA230A and WCA280A User Manual.

1. Press the **DEMOD** key on the front panel.
2. Press the side key **Standard...** → **3GPP-R6-DL**.
3. Press the **FREQUENCY/CHANNEL** key on the front panel to set frequency.

If you use the channel table, do these steps:

- a. Press the **Channel Table...** side key and select **W-CDMA-DL**.
- b. Press the **Channel** side key and select a channel by rotating the general purpose knob.

The center frequency is set to the value corresponding to the channel.

4. Press the **SPAN** key on the front panel to set the span.
5. Press the **AMPLITUDE** key on the front panel to set the amplitude appropriately.

NOTE. If the input level is too high, **A/D OVERFLOW** displays in the red box at the center top of the screen. If this occurs, raise the reference level.

6. Press the **TIMING** key on the front panel and then the **Acquisition Length** side key to set the time length to acquire one block.

Suppose that one block contains M frames; the acquisition length is calculated with this equation:

$$(\text{One block acquisition length}) = M \times (\text{One frame acquisition length})$$

One frame acquisition length is determined by span and indicated on the **Spectrum Length** side key.

The number of frames M required for measuring N slots must meet the following condition:

$$M > K \times (N + 1.2) + 1$$

where

- K = 16.7 (for the span of 20 MHz and 15 MHz)
- 8.34 (for the span of 10 MHz)
- 4.17 (for the span of 5 MHz)

7. After acquiring measurement data, stop the data acquisition. If you are acquiring data in the continuous mode, press the **RUN/STOP** key.
8. Press the **MEASURE** key on the front panel and select measurement items. For example, press the **Power Codogram** side key to observe the code domain power spectrogram.
9. Press the **MEAS SETUP** key on the front panel and set the measurement parameters. Refer to page 2-5 for details of the Meas Setup menu.
10. Set the analysis range in the overview using the Timing menu. Refer to the *WCA230A and WCA280A User Manual* for the details.
11. Press the **MEAS SETUP** key on the front panel and then the **Analyze** side key to start processing the frames in the analysis range. The results are displayed in the main view.

Change the scale and format of the view as needed. Refer to page 2-8 for setting views specific to the 3GPP-R6 downlink analysis.
12. If the level of input signals is low, the waveform may not be displayed correctly. In this case, perform the following procedure:

NOTE. *The 3GPP-R6 downlink signal analysis may not be performed correctly if the P-SCH, S-SCH, and PCPICH channels are too low to be detected. An error occurs when one of these channel levels is lower than several tenths the sum of other channel levels. In this case, set Scrambling Code Search to Off and specify the scrambling code with the Scrambling Code side key.*

- a. Press the **MEAS SETUP** key on the front panel.
- b. Press the **Modulation Parameters...** side key.
- c. Press the **Scrambling Code Search** side key to select **Off**.
- d. Press the **Scrambling Code** side key and enter the scrambling code.

The analyzer performs measurement with the value set here in place of detecting the scrambling code.
- e. Press the **MEAS SETUP** key on the front panel.
- f. Press the **Analyze** side key to perform measurement for the frames in the analysis range.

Figure 2-2 shows an example of the code domain power measurement.



Figure 2-2: Code domain power measurement example

Change the scale and format of the view as needed. Refer to page 2-8 for setting views specific to the 3GPP-R6 downlink analysis.

Measurement Setup Menu

Press the **MEAS SETUP** key on the front panel to set the measurement parameters. The Meas Setup menu for the 3GPP-R6 downlink modulation analysis contains the following controls:

Analyze Performs analysis for time slots in the analysis range.

NOTE. When you change the parameter setting(s) in the Meas Setup menu, press the **Analyze** side key to perform the measurement for the modified setting(s).

Modulation Parameters...

Sets a measurement parameter to a non-standard value. The following controls are provided:

Scrambling Code Search. Selects whether to perform analysis by detecting a scrambling code from input signals.

- **On.** Detects a scrambling code automatically from the input signal to perform the measurement.
- **Off. Default.** Performs measurement using the scrambling code that has been set manually with **Scrambling Code** described below.

NOTE. The manual mode (*Scrambling Code Search Off*) should be used with the appropriate scrambling code for reliable detection when either multiple code channels are active or the sync channels have low power.

Also refer to *Note* on page 2-3.

Scrambling Code. Sets the scrambling code number when you select Off in Scrambling Code Search. The analyzer performs measurement using the set scrambling code. Range: 0 to 24575 (default: 0).

The 3GPP standard defines the scrambling code with the following formulas. Input the n value to set the code.

$$\begin{aligned} \text{Primary scrambling code: } n &= 16 * i && \text{where } i = 0 \text{ to } 511 \\ \text{Secondary scrambling code: } n &= 16 * i + k && \text{where } k = 1 \text{ to } 15 \end{aligned}$$

Use Alternative Scramb. Code... Selects the de-spread method to display the measurement results:

- **Not Used. Default.** Uses the primary scrambling code only (without the left and the right alternative scrambling codes) to de-spread the input signal.
- **Primary.** Uses the primary scrambling with the left and the right alternative scrambling codes to de-spread the input signal.

- **Left Alternative.** Uses the left alternative scrambling code to de-spread the input signal.
- **Right Alternative.** Uses the right alternative scrambling code to de-spread the input signal.

Primary, Left Alternative and Right Alternative use the proprietary algorithm to enhance the sensitivity by approximately 20 to 30 dB compared to **Not Used**. **Not Used** does not use the alternative scrambling codes for faster measurement.

Use SCH Part. Selects whether to include or exclude the SCH (Synchronization Channel) portion when calculating the code domain power.

- **On.** Calculates the code domain power by including the SCH portion.
- **Off. Default.** Calculates the code domain power by excluding the SCH portion.

Composite. Determines whether to perform the composite analysis (automatic detection of symbol rate).

- **On. Default.** Specifies that the composite analysis is performed.
- **Off.** Specifies that the composite analysis is not performed.

NOTE. *You should usually specify that composite analysis is performed. If a normal analysis does not result, select Off in this command and select a specific symbol rate with Symbol Rate in the View: Define menu.*

16QAM Detection. Selects whether to detect the QPSK or 16QAM code channel automatically.

- **On. Default.** Automatically detects whether the code channel is QPSK or 16QAM.
- **Off.** Assumes that all code channels are QPSK.

Measurement Filter... Selects a filter for demodulating digitally-modulated signals:

- None (no filter)
- RootRaisedCosine (default)

Reference Filter... Selects a filter for creating reference data:

- None (no filter)
- RaisedCosine (default)
- Gaussian

For the filters, refer to *Process Flow of Digitally-Modulated Signal* in the *WCA230A and WCA280A User Manual*.

Filter Parameter. Sets the a/BT value for Measurement Filter and Reference Filter described above. Range: 0.0001 to 1 (default: 0.22).

EVM IQ Origin Offset. Determines whether to include the I/Q origin offset in the EVM (Error Vector Magnitude), Rho (waveform quality), and PCDE (Peak Code-Domain Error) calculation.

- **Include.** *Default.* Includes the I/Q origin offset in the calculation.
- **Exclude.** Excludes the I/Q origin offset from the calculation.

E-AGCH Code	Specifies the E-AGCH (E-DCH Absolute Grant Channel) code. Range: Channel 0 to 127 (default: 0).
E-RGCH/E-HICH Code	Specifies the E-RGCH (E-DCH Relative Grant Channel) or E-HICH (E-DCH HARQ Acknowledgement Indicator Channel) code. Range: Channel 0 to 127 (default: 0).
E-RGCH Sequence Index	Specifies the E-RGCH sequence index number. Range: 0 to 39 (default: 0).
E-HICH Sequence Index	Specifies the E-HICH sequence index number. Range: 0 to 39 (default: 0).
Update Timeslot Table	Re-analyzes the existing time slot data to update the table display after you change the subframe offset manually or abort the Analyze (top side key) operation.
Auto Carrier	Selects whether to detect the carrier automatically. <ul style="list-style-type: none"> ■ On. <i>Default.</i> Automatically detects the carrier for every frame. The error from the center frequency is shown on the Freq Error side key. ■ Off. Sets the carrier frequency using Frequency Offset described below.
Frequency Offset	Sets the carrier frequency when Auto Carrier is selected to Off. Input the carrier offset from the center frequency.

Scale and Format of View

The following main views are specific to the measurement items of the 3GPP-R6 downlink analysis in the Demod mode:

- Code domain power
- Power codogram
- Code power versus Time slot
- Code power versus Symbol
- Symbol constellation
- Symbol EVM
- Symbol eye diagram
- Symbol table
- Modulation accuracy
- Modulation accuracy versus Time slot

The scale and format of view are controlled by the View menu. This section describes the View: Define menu and the View: Scale menu for each view.

View: Define Menu

The View: Define menu is common to all main views of the 3GPP-R6 downlink measurement items. It contains the following controls:

Show Views. Selects the view style:

- **Single.** Displays only the view selected by the VIEW: **SELECT** key.
- **Multi. Default.** Displays the overview, subview, and main view.

Overview Content... Selects a view to display in the overview:

- Waveform (power versus time)
- Spectrogram

Subview Content... Selects a view to display in the subview:

- Spectrum
- Code Domain Power
- Power Codogram
- CDP vs Time Slot (Code Domain Power versus Time Slot)
- CDP vs Symbol (Code Domain Power versus Symbol)
- EVM vs Time Slot
- Symbol Constellation
- Symbol EVM
- Symbol Eye Diagram
- Symbol Table
- Modulation Accuracy

Time Slot. Sets a time slot number to position the marker.

Range: 0 to [(the number of slots) – 1] (default: 0).

Channelization Code. Sets a channelization code number to position the marker.

Range: Channel 0 to 511 (default: 0).

Multi Slot. Selects whether to display single slot or multiple slots in the main view. This selection is effective only in the code domain power versus symbol view and the symbol EVM view. In the other views, it has no effect.

- **Off.** Displays a time-slot selected by the **Time Slot** side key.
- **On.** Displays up to 15 time-slots in the main view.

Menu Off. Turns off the side menu on screen to expand the waveform and measurement result display. Press the **MENU** side key when you return to the original display.

Show SCH Part. Determines whether to display SCH (Synchronization Channel) at the beginning of data.

- **Off.** Hides the SCH part.
- **On.** Shows the SCH part.

Symbol Rate... Sets the symbol rate for displaying symbol constellation:

- 960 k
- 480 k
- 240 k
- 120 k
- 60 k
- 30 k
- 15 k
- 7.5 k
- Composite

The default is Composite for multi-rate.

Column Items to Display... Turns on or off the following items in the time-slot table.

Table 2-1: Column items

Column title	Channel	Description	Value
SSCH	-	S-SCH	Channel number
SCG	-	Scrambling Code Group	Group number
SCN	-	Scrambling Code Number	Code number
AGS	E-AGCH	Absolute Grant Scope	0 or 1
AGV	E-AGCH	Absolute Grant Value	0 to 31
RG	E-RGCH	Relative Grant	UP, DOWN, or HOLD
ACK	E-HICH	ACK/NACK	ACK, NACK0 or NACK1 ¹

¹ NACK0: NACK for RLSs not containing the serving E-DCH cell. (RLS: Radio Link Set)
 NACK1: NACK for RLS containing the serving E-DCH cell.

The time slot table is displayed in the main view, as shown in Figure 2-3, with waveforms and measurement results.

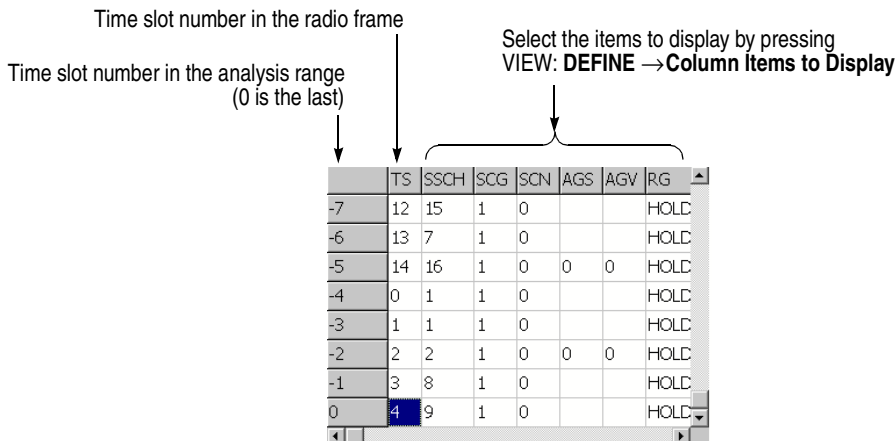

Figure 2-3: Time slot table (at the lower left of the screen)

Scroll Timeslot Table. Scrolls the time slot table to the right and left.

Menu Off. Turns off the side menu on screen to expand the waveform and measurement result display. Press the **MENU** side key when you return to the original display.

Code Domain Power

When you select Code Domain Power in the Measure menu, the code domain power is displayed for each short code, as shown in Figure 2-4.

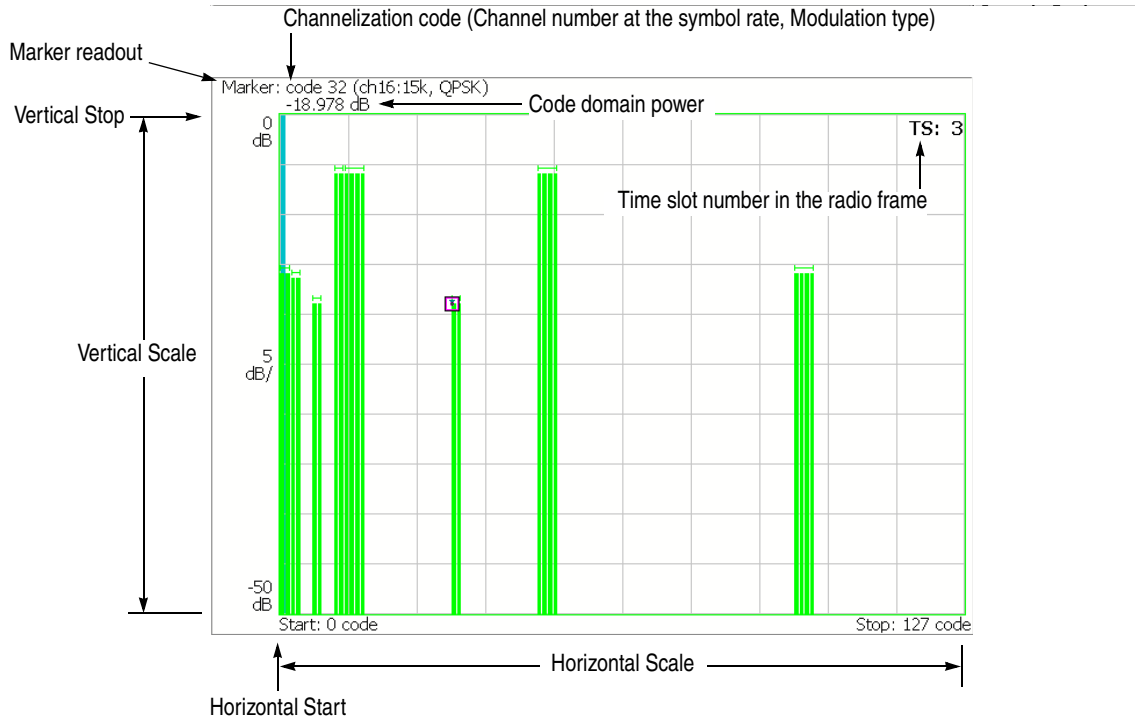

Figure 2-4: Code domain power

View: Scale Menu Use the following controls to scale the view:

Auto Scale. Sets the start value and the scale of the vertical axis automatically to fit the waveform to the screen.

Horizontal Scale. Sets the scale of the horizontal axis.
Range: 16 to 512 channels.

Horizontal Start. Sets the start channel number of the horizontal axis.
Range: 0 to [512 – (Horizontal Scale)].

Vertical Scale. Sets the scale of the vertical axis.
Range: 50 μ to 50 dB.

Vertical Stop. Sets the maximum value (top edge) of the vertical axis.
Range: –50 to Vertical Scale [dB].

Full Scale. Sets the scale of the vertical axis to the default full scale value.

Y Axis. Selects whether to represent the vertical axis (amplitude) with relative or absolute values.

- **Relative.** The vertical axis represents power relative to the total power of all channels.
- **Absolute.** The vertical axis represents absolute power of each channel.

Power Codogram

When you select Power Codogram in the Measure menu, the code domain power is displayed in spectrogram, as shown in Figure 2-5.

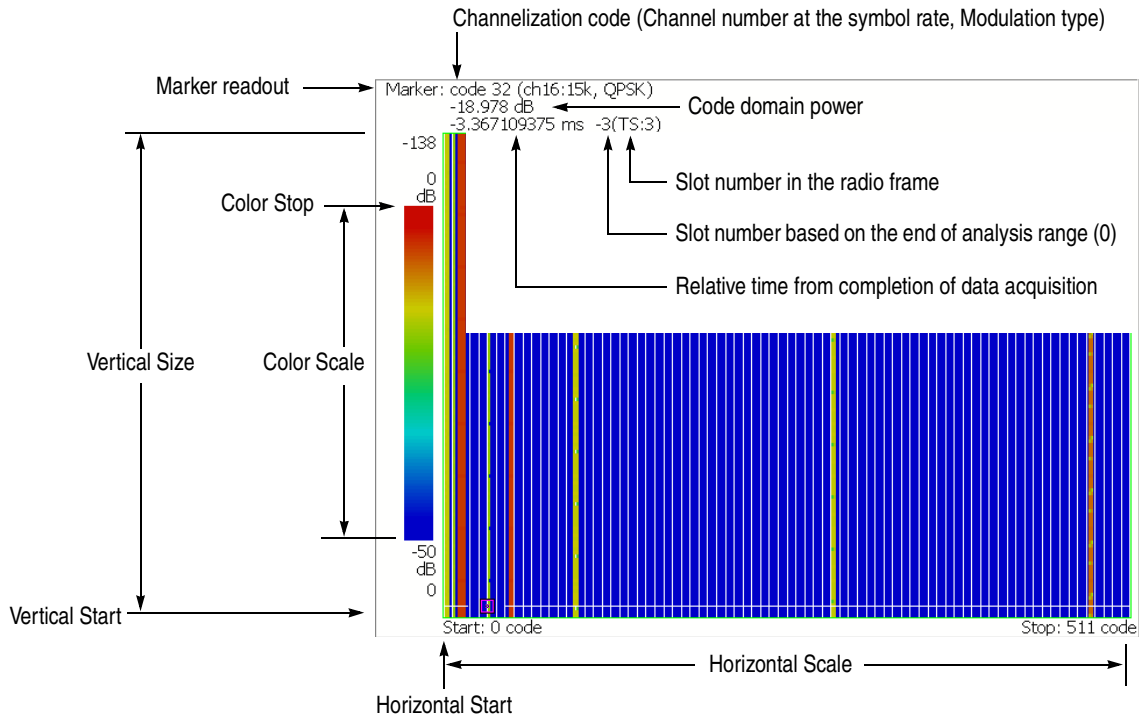

Figure 2-5: Power codogram

View: Scale Menu Use the following controls to scale the view:

Auto Scale. Sets the start value and the scale of the vertical axis automatically to fit the waveform to the screen.

Horizontal Scale. Sets the scale of the horizontal axis.
Range: 16 to 512 channels.

Horizontal Start. Sets the start channel number of the horizontal axis.
Range: 0 to [512 – (Horizontal Scale)].

Vertical Size. Sets the full scale of the vertical axis in frames.
Range: 58 to 59392 frames.

Vertical Start. Sets the start frame number of the vertical axis.

Color Scale. Sets the range of the color axis:

- 5 dB
- 10 dB
- 20 dB
- 50 dB

The spectrogram is displayed in 100 steps (100 colors) from the minimum value (blue) to the maximum value (red) in the default state.

Color Stop. Sets the maximum value (top edge) of the color axis.
Range: –50 to Color Scale [dB].

Full Scale. Sets Color Stop to 0 (zero) and Color Scale to 50 dB.

Y Axis. Selects whether to represent the Y (color) axis with relative or absolute values.

- **Relative.** The Y axis represents power relative to the total power of all channels.
- **Absolute.** The Y axis represents absolute power of each channel.

Code Power versus Time Slot

When you select Code Power versus Time Slot in the Measure menu, the code domain power is displayed for each slot, as shown in Figure 2-6.

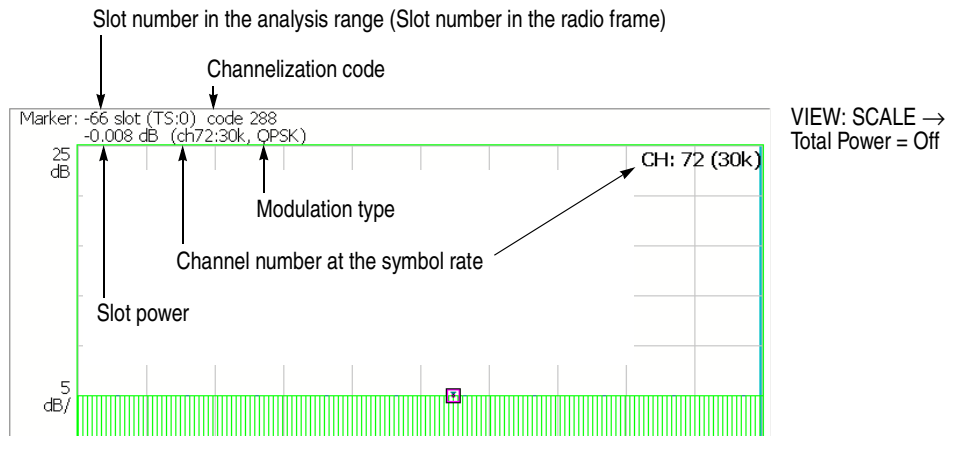
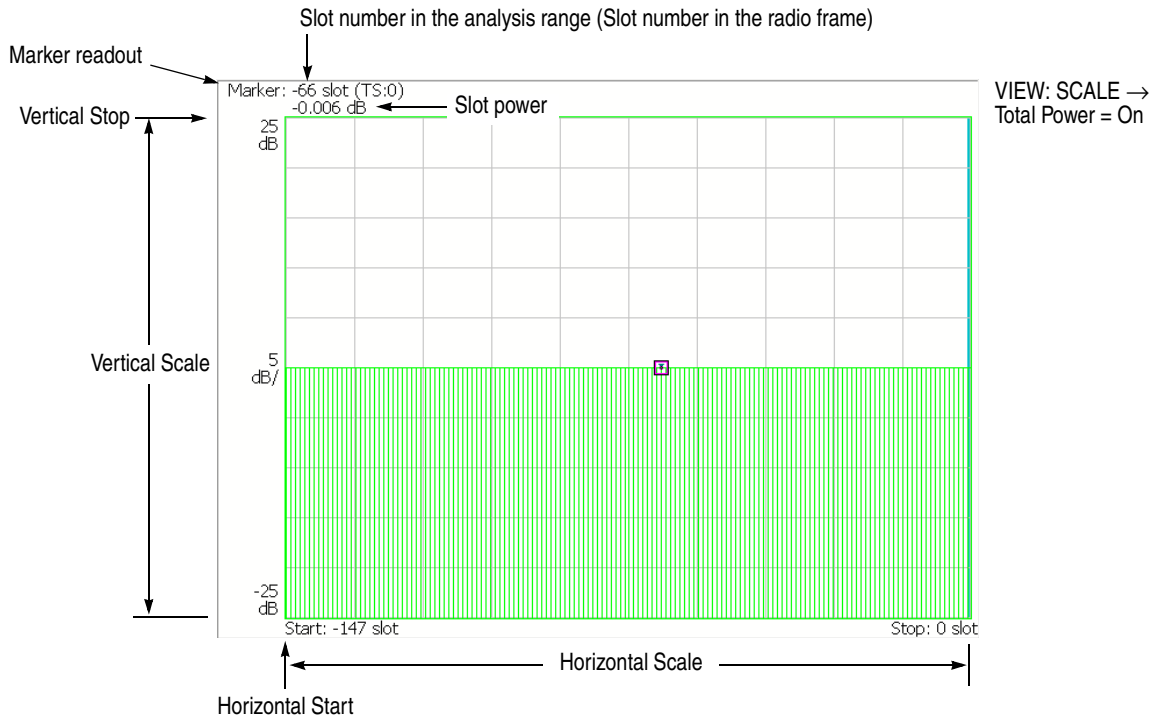

Figure 2-6: Code power versus Time slot

View: Scale Menu

Use the following controls to scale the view:

Auto Scale. Sets the start value and the scale of the vertical axis automatically to fit the waveform to the screen.

Horizontal Scale. Sets the scale of the horizontal axis (number of slots).
Range: $N/8$ to N slots (N : the number of slots in the analysis range.)

Horizontal Start. Sets the start slot number of the horizontal axis.
Range: $-(N - 1)$ to $[1 - (\text{Horizontal Scale})]$.

Vertical Scale. Sets the scale of the vertical axis.
Range: 50μ to 50 dB.

Vertical Stop. Sets the maximum value (top edge) of the vertical axis.
Range: -25 to $[(\text{Vertical Scale}) + 25]$ dB.

Full Scale. Sets the scale of the vertical axis to the default full scale value.

Y Axis. Selects whether to represent the vertical (amplitude) axis with relative or absolute values.

- **Relative.** The vertical axis represents time-slot power relative to the power of the first time-slot in the analysis range.
- **Absolute.** The vertical axis represents absolute power of time slots.

Select Power. Selects the channel to show the power for each time slot.

- **Code.** Shows the power of all channels or the specified channel depending on the setting of Total Power described below.
- **PSCH.** Shows the power of the PSCH (Primary Synchronization Channel).
- **SSCH.** Shows the power of the SSCH (Secondary Synchronization Channel).

Total Power. Determines whether to display the total power for each time slot when the Select Power is set to Code.

- **On. Default.** Displays the total power of all channels for each time slot.
- **Off.** Displays power of the channel specified using Channelization Code in the View: Define menu (refer to page 2-9).

Code Power versus Symbol

When you select Code Power versus Symbol in the Measure menu, the code domain power is displayed for each symbol, as shown in Figure 2-7.

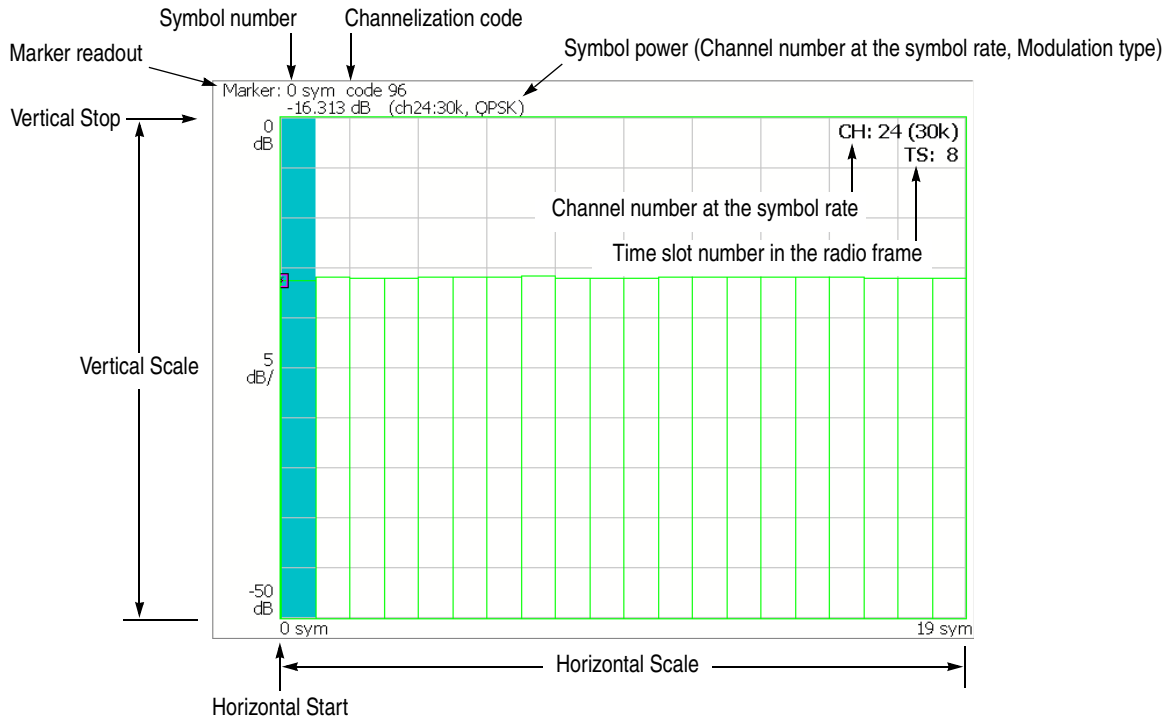

Figure 2-7: Code domain power versus Symbol

View: Scale Menu

Use the following controls to scale the view:

Auto Scale. Sets the start value and the scale of the vertical axis automatically to fit the waveform to the screen.

Horizontal Scale. Sets the scale of the horizontal axis (number of symbols).
Range: 0 to 640 symbols.

Horizontal Start. Sets the start symbol number of the horizontal axis.
Range: 0 to [(initial value of Horizontal Scale) – (set value of Horizontal Scale)].

Vertical Scale. Sets the scale of the vertical axis.
Range: 50 μ to 50 dB.

Vertical Stop. Sets the maximum value (top edge) of the vertical axis.
Range: –50 to Vertical Scale [dB].

Full Scale. Sets the scale of the vertical axis to the default full-scale value.

Y Axis. Selects whether to represent the vertical (amplitude) axis with relative or absolute values.

- **Relative.** The vertical axis represents power relative to the total power of all channels.
- **Absolute.** The vertical axis represents absolute power of each channel.

Symbol Constellation

The symbol constellation is displayed when you select Symbol Constellation in the Measure menu, as shown in Figure 2-8.

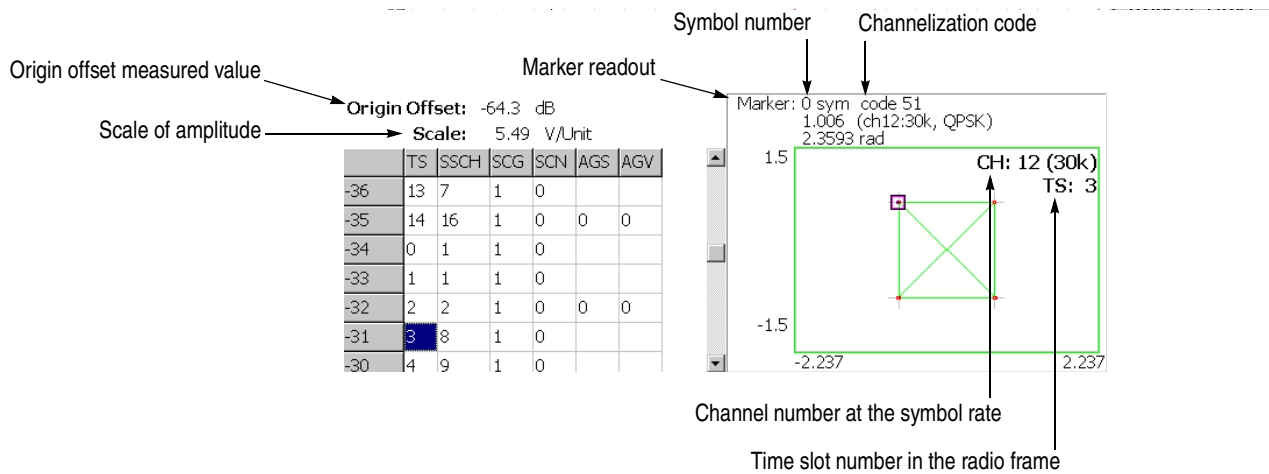

Figure 2-8: Symbol constellation

View: Scale Menu

Use the following controls to set the scale:

Measurement Content... Selects vector or constellation display.

- **Vector.** Selects vector display. A signal represented by phase and amplitude is displayed in polar coordinate or IQ diagram. The red point indicates the symbol position of the measured signal, and the yellow trace indicates the locus of the signal between symbols.
- **Constellation.** Selects constellation display. It is the same as the vector display, except that only symbols of the measured signal are indicated in red, and the locus between symbols is not shown. The cross marks indicate the symbol positions of an ideal signal.

You can select degree or radian for the angular unit by pressing **SYSTEM** → **Instrument Setup...** → **Angular Units...**

Symbol EVM

When you select Symbol EVM in the Measure menu, EVM (Error Vector Magnitude) is displayed for each symbol, as shown in Figure 2-9.

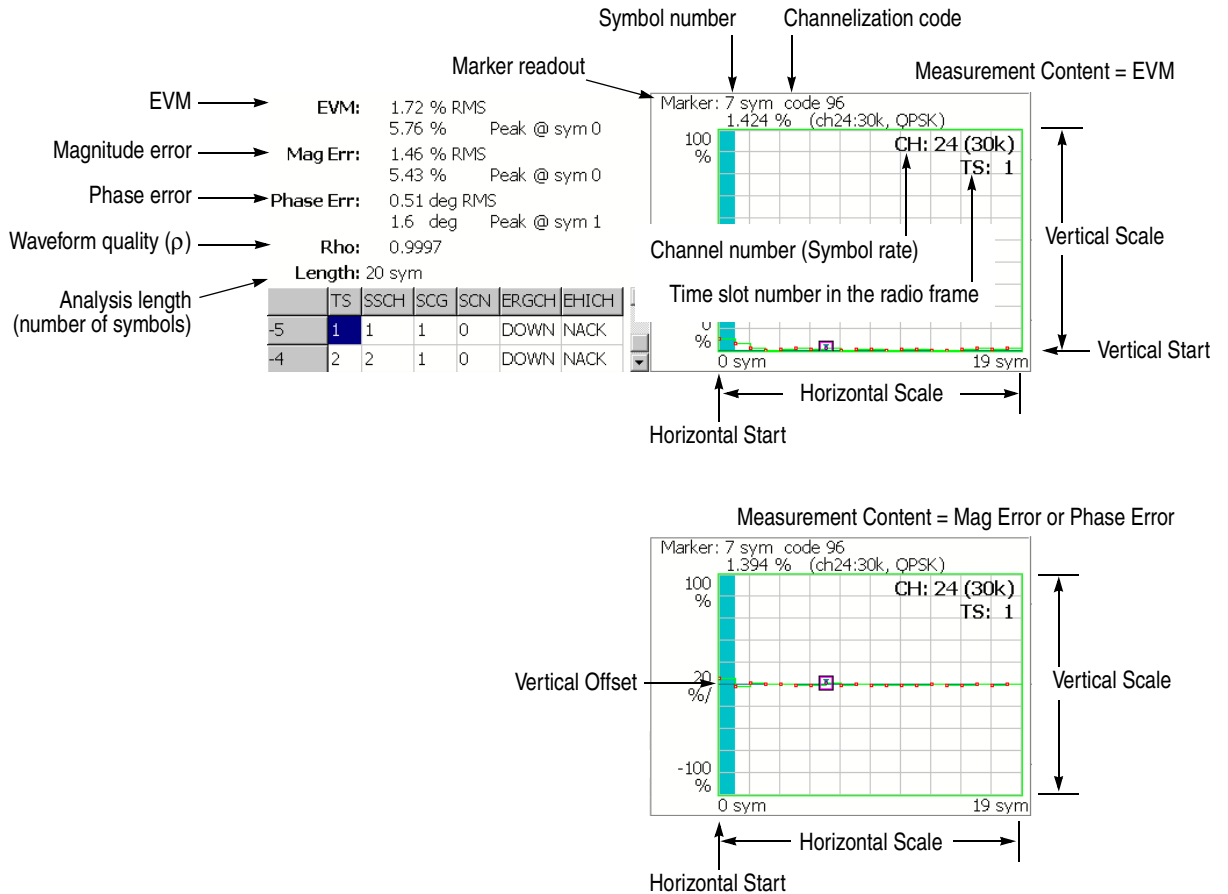

Figure 2-9: Symbol EVM

NOTE. For the symbol EVM, the measurement results of EVM, magnitude and phase error are calculated and displayed with EVM IQ Origin Offset (refer to page 2-7) set to Include even if you set it to Exclude.

View: Scale Menu

Use the following controls to scale the view:

Auto Scale. Sets the start value and the scale of the vertical axis automatically to fit the waveform to the screen.

Horizontal Scale. Sets the scale of the horizontal axis (number of symbols).
Range: 0 to 640 symbols.

Horizontal Start. Sets the start symbol number of the horizontal axis.
Range: 0 to [(initial value of Horizontal Scale) – (set value of Horizontal Scale)].

Vertical Scale. Sets the scale of the vertical axis.
Refer to Table 2-2 for the setting range.

Vertical Start. Sets the minimum value (bottom edge) of the vertical axis when the measurement content is EVM. Refer to Table 2-2 for the setting range.

Vertical Offset. Sets the center value ((maximum + minimum) / 2) of the vertical axis when the measurement content is Mag Error or Phase Error.
Refer to Table 2-2 for the setting range.

Full Scale. Sets the scale of vertical axis to the default full-scale value.

Measurement Content... Selects how to display the vertical axis (refer to Table 2-2).

- **EVM.** Represents the vertical axis with EVM.
- **Mag Error.** Represents the vertical axis with magnitude error.
- **Phase Error.** Represents the vertical axis with phase error.

Table 2-2: Vertical scale setting range, Symbol EVM

Measurement Content...	Vertical Scale	Vertical Start	Vertical Offset
EVM	100μ to 100%	-100 to 100%	-
Mag Error	200μ to 200%	-	-200 to 200%
Phase Error	450μ to 450°	-	-450 to 450°

You can select degree or radian for the angular unit by pressing **SYSTEM** → **Instrument Setup...** → **Angular Units...**

Symbol Eye Diagram

The symbol eye diagram is displayed when you select Symbol Eye Diagram in the Measure menu, as shown in Figure 2-10.

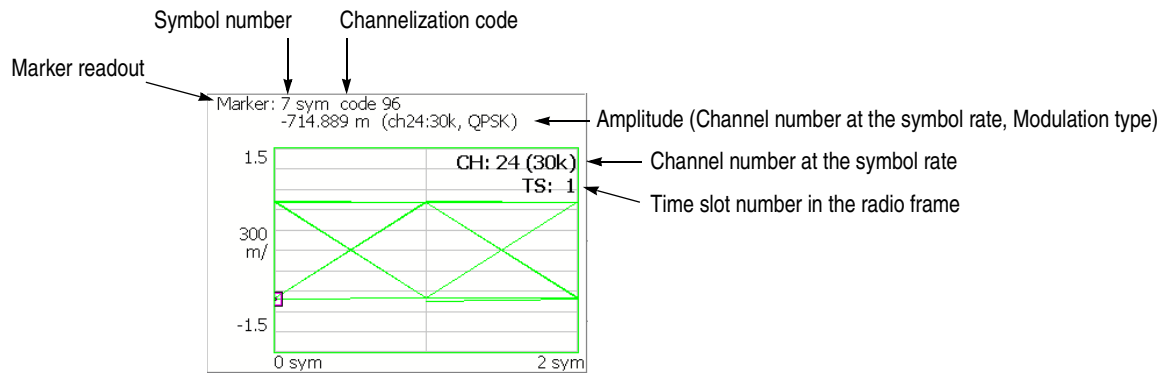

Figure 2-10: Symbol eye diagram

View: Scale Menu Use the following controls to scale the view.

Measurement Content... Selects the vertical axis of eye diagram.

- **I. Default.** Displays I data on the vertical axis.
- **Q.** Displays Q data on the vertical axis.
- **Trellis.** Displays phase on the vertical axis.

Eye Length. Enters the number of display symbols on the horizontal axis.
Range: 1 to 16 (default: 2)

Symbol Table

The symbol table is displayed when you select Symbol Table in the Measure menu, as shown in Figure 2-11.

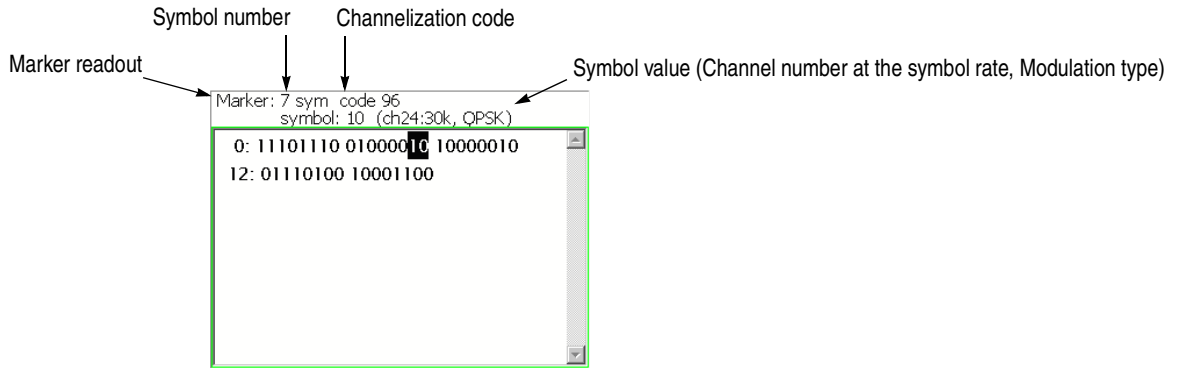

Figure 2-11: Symbol table

View: Scale Menu

Use the following controls to scale the view:

Radix. Selects the radix for displaying the table:

- **Hex (packed).** Displays data in the hexadecimal form every 4 bits.
- **Hex.** Displays data in the hexadecimal form every modulation symbol.
- **Oct.** Displays data in the octal form every modulation symbol.
- **Bin.** *Default.* Displays data in the binary form.

Hex and Oct indicate values of binary data string in units of modulation symbol. When a signal contains one or two-bit data in a symbol, you can select Hex (packed) to represent multiple symbols as a hexadecimal digit every 4 bits. For example, the BPSK modulation signal contains one-bit data in a symbol, so the symbol table has the same values for Hex, Oct, and Bin. But Hex (packed) represents every 4 symbols as a hexadecimal digit.

Rotate. Sets the start position. Range: 0 to 3.

Modulation Accuracy

The constellation of all channels before the de-spread is displayed when you select Modulation Accuracy in the Measure menu.

When you press the VIEW: **SELECT** key on the front panel to select the constellation view, the measurement results for the time slot are displayed instead of the overview, as shown in Figure 2-12.

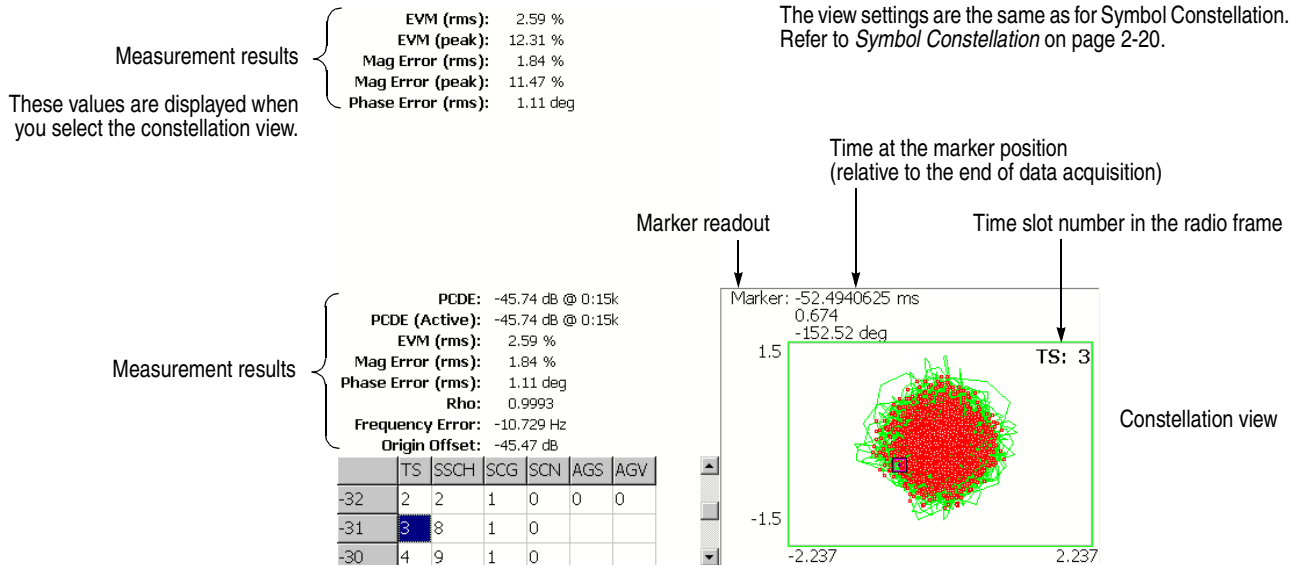

Figure 2-12: Modulation accuracy

The following table shows the measurement results readout.

Measurement results	Description
PCDE	PCDE [dB] @ channel: symbol rate (I/Q)
PCDE (Active)	PCDE [dB] for active channels only @ channel: symbol rate (I/Q)
EVM (rms) ¹	RMS value of EVM [%]
(Peak) ¹	Peak value of EVM [%]
Mag Error (rms) ¹	RMS value of magnitude error [%]
(Peak) ¹	Peak value of magnitude error [%]
Phase Error (rms) ¹	RMS value of phase error [degrees or radians]
(Peak)	Peak value of phase error [degrees or radians]
Rho	Waveform quality (ρ)
Frequency Error	Frequency error [Hz]
Origin Offset	Origin offset (IQ feedthrough) [dB]

¹ Displayed on the upper-left corner of the screen when you select the constellation view.

Modulation Accuracy versus Time Slot

The Modulation accuracy versus Time slot measurement displays EVM, magnitude error, phase error, PCDE (Peak Code Domain Error), or Frequency error for each time slot in the main view. Figure 2-13 shows an example of EVM (rms).

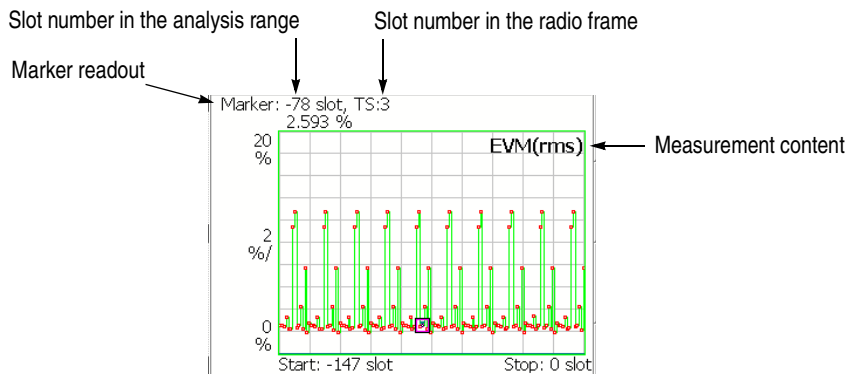

Figure 2-13: Modulation accuracy versus Time slot, EVM (rms)

View: Scale Menu

Use the following controls to scale the view.

Auto Scale. Sets the start value and the scale of the vertical axis automatically to fit the waveform to the screen.

Horizontal Scale. Sets the scale of the horizontal axis (number of slots).
Range: $N/8$ to N slots (N : the number of slots in the analysis range.)

Horizontal Start. Sets the start slot number of the horizontal axis.
Range: $-(N - 1)$ to $[1 - (\text{Horizontal Scale})]$.

Vertical Scale. Sets the scale of the vertical axis.
Refer to Table 2-3 for the setting range.

Vertical Start. Sets the minimum value (bottom edge) of the vertical axis when the measurement content is EVM. Refer to Table 2-3 for the setting range.

Vertical Stop. Sets the maximum value (top edge) of the vertical axis when the measurement content is PCDE. Refer to Table 2-3 for the setting range.

Vertical Offset. Sets the center value $((\text{maximum} + \text{minimum}) / 2)$ of the vertical axis when the measurement content is Mag Error, Phase Error, or Frequency Error. Refer to Table 2-3 for the setting range.

Full Scale. Sets the scale of vertical axis to the default full-scale value.

Measurement Content... Selects the measurement content (refer to Table 2-3).

Table 2-3: Vertical scale setting range, Modulation accuracy versus Time slot

Measurement Content...	Vertical Scale	Vertical Start	Vertical Stop	Vertical Offset
EVM (rms)	100 μ to 100%	-100 to 100%	-	-
EVM (peak)	100 μ to 100%	-100 to 100%	-	-
Mag Error (rms)	200 μ to 200%	-	-	-200 to 200%
Mag Error (peak)	200 μ to 200%	-	-	-200 to 200%
Phase Error (rms)	450 μ to 450°	-	-	-450 to 450°
Phase Error (peak)	450 μ to 450°	-	-	-450 to 450°
PCDE (Peak Code Domain Error)	100 μ to 100 dB	-	-100 to 100 dB	-
Frequency Error	10 m to 10 kHz	-	-	-10 k to 10 kHz

You can select degree or radian for the angular unit by pressing **SYSTEM**
 → **Instrument Setup...** → **Angular Units...**

Uplink Analysis

This section describes the basic operation for the 3GPP-R6 uplink analysis in the Demod (modulation analysis) mode. You can access the measurement item by pressing **DEMOD** → **Standard...** → **3GPP-R6-UL** as shown in Figure 2-14.

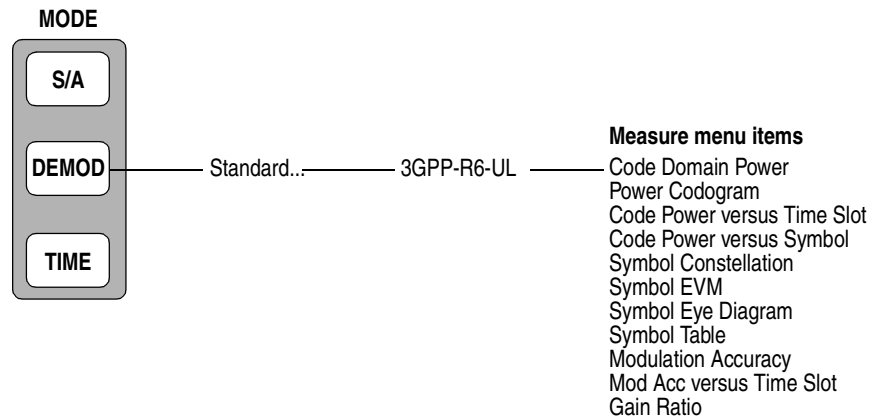

Figure 2-14: Uplink analysis measurement menu in the Demod mode

The measurement in the Demod mode is based on the digital modulation analysis function. For the digital modulation analysis, refer to the *WCA230A and WCA280A User Manual*.

Measurement Procedure

The following procedure shows you how to acquire data from multiple slots in advance, measure continuous data, and obtain continuous code domain power:

NOTE. For details on setting frequency, span, and amplitude, refer to the WCA230A and WCA280A User Manual.

1. Press the **DEMOD** key on the front panel.
2. Press the side key **Standard...** → **3GPP-R6-UL**.
3. Press the **FREQUENCY/CHANNEL** key on the front panel to set frequency.

If you use the channel table, do these steps:

- Press the **Channel Table...** side key and select **W-CDMA-UL**.
- Press the **Channel** side key and select a channel by rotating the general purpose knob.

The center frequency is set to the value corresponding to the channel.

4. Press the **SPAN** key on the front panel to set the span.
5. Press the **AMPLITUDE** key on the front panel to set the amplitude appropriately.

NOTE. If the input level is too high, **A/D OVERFLOW** displays in the red box at the center top of the screen. If this occurs, raise the reference level.

6. Press the **TIMING** key on the front panel and then the **Acquisition Length** side key to set the time length to acquire one block.

Suppose that one block contains M frames; the acquisition length is calculated with this equation:

$$(\text{One block acquisition length}) = M \times (\text{One frame acquisition length})$$

One frame acquisition length is determined by span and indicated on the Spectrum Length side key.

The number of frames M required for measuring N slots must meet the following condition:

$$M > K \times (N + 1.2) + 1$$

where

K = 16.7 (for span 20 MHz and 15 MHz)

8.34 (for span 10 MHz)

4.17 (for span 5 MHz)

7. After acquiring measurement data, stop the data acquisition. If you are acquiring data in the continuous mode, press the **RUN/STOP** key.
8. Press the **MEASURE** key on the front panel to select measurement items. For example, press the **Power Codogram** side key to observe the code domain power spectrogram.
9. Press the **MEAS SETUP** key on the front panel and set the measurement parameters. Refer to page 2-32 for details of the Meas Setup menu.
10. Set the analysis range in the overview using the Timing menu. Refer to the *WCA230A and WCA280A User Manual* for the details.
11. Press the **MEAS SETUP** key on the front panel and then the **Analyze** side key to start processing the frames in the analysis range. The results are displayed in the main view.

Change the scale and format of the view as needed. Refer to page 2-39 for setting views specific to the 3GPP-R6 uplink analysis.

Figure 2-15 shows an example of the code domain power measurement.

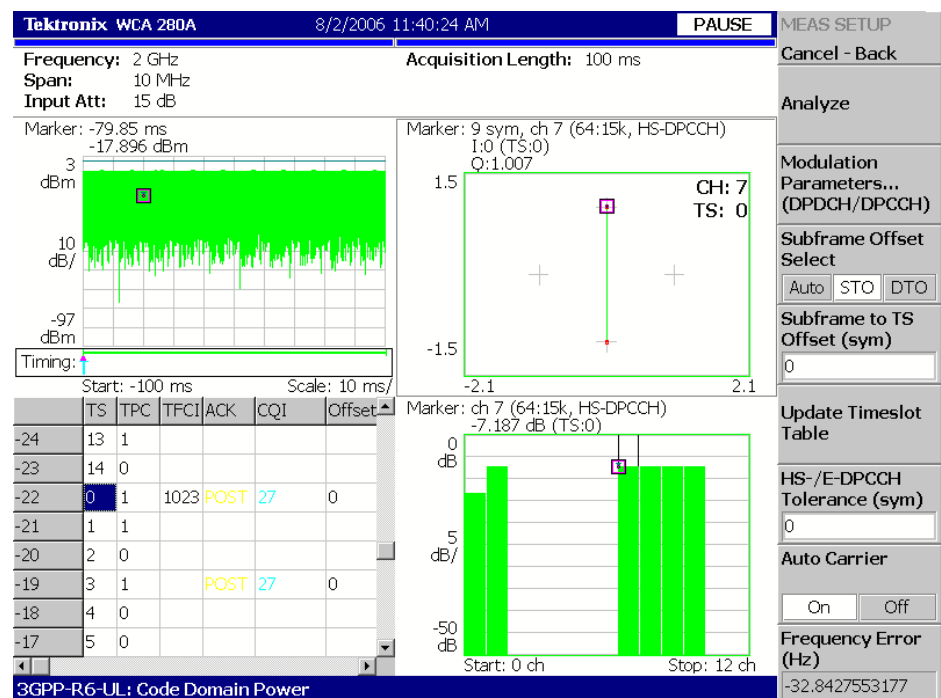

Figure 2-15: Code domain power measurement example

Measurement Setup Menu

Press the **MEAS SETUP** key on the front panel to set the measurement parameters. The Meas Setup menu for the 3GPP-R6 uplink modulation analysis contains the following controls:

Analyze Performs analysis for time slots in the analysis range.

NOTE. When you change settings in the Meas Setup menu, press the **Analyze** side key to perform the measurement for the modified setting(s).

Modulation Parameters... Sets parameters to demodulate the input signal. The following setting items are provided:

Measurement Mode. Selects the type of uplink signal:

- DPDCH/DPCCH (default)
- PRACH
- PCPCH

Scrambling Code Type. Available for the DPDCH/DPCCH measurement mode. Selects the scrambling code type:

- Long (default)
- Short

Scrambling Code. Sets the scrambling code number. Range: 0 to 16777215 (default: 0).

Configuration... Available for the DPDCH/DPCCH measurement mode. Selects the channel configuration (defined in 3GPP-R6).

- **Auto.** *Default.* Detects the configuration automatically.
- **1.** Selects Configuration #1.
- **2.** Selects Configuration #2.
- **3.** Selects Configuration #3.

For details on the Configuration, refer to the 3GPP-R6 specifications.

DPCCH Format... Available for the DPDCH/DPCCH measurement mode.
Selects the DPCCH format to decode TFCI.

- **Auto. Default.** Detects the Slot Format automatically.
- **0.** Selects Slot Format #0 (including 0A and 0B).
- **1.** Selects Slot Format #1.
- **2.** Selects Slot Format #2 (including 2A and 2B).
- **3.** Selects Slot Format #3..

NOTE. When selecting Slot Format #1 or #3, the time-slot table does not show TFCI. (Refer to page 2-43 for the time-slot table.)

For details on the Slot Format, refer to the 3GPP-R6 specifications.

HS-/E-DPCCH Tolerance. Available for the DPDCH/DPCCH measurement mode.
Sets the number of symbols which are allowed to be different from the 3GPP-R6 specifications for decoding HS-DPCCH and E-DPCCH.
Range: 0 to 5 symbols (default: 0).

DTX Detection Threshold. Available for the DPDCH/DPCCH measurement mode.
Sets the threshold level to detect the DTX state.
Range: –20 to 0 dB relative to the DPCCH power (default: –11.8 dB).

Threshold. Sets the threshold level to detect a burst.
Range: –100 to 10 dB relative to the reference level (default: –30 dB).

Measurement Filter... Selects a filter for demodulating digitally-modulated signals:

- None (no filter)
- RootRaisedCosine (default)

Reference Filter... Selects a filter for creating reference data:

- None (no filter)
- RaisedCosine (default)
- Gaussian

For the filters, refer to *Process Flow of Digitally-Modulated Signal* in the *WCA230A and WCA280A User Manual*.

Filter Parameter. Sets an α /BT value for Measurement Filter and Reference Filter described above. Range: 0.0001 to 1 (default: 0.22)

EVM IQ Origin Offset. Determines whether or not to include the I/Q origin offset in the EVM (Error Vector Magnitude), Rho (waveform quality), and PCDE (Peak Code Domain Error) calculation.

- **Include.** *Default.* Includes the I/Q origin offset in the calculation.
- **Exclude.** Excludes the I/Q origin offset from the calculation.

EVM Transient Periods of 25 us. Determines whether or not to include the transient periods (both 25 μs ends of the time slot) from the EVM and PCDE calculation.

- **Include.** Calculates EVM and PCDE using all chips of the slot.
- **Exclude.** *Default.* Excludes both 25 μs ends of the slot from the calculation.

Subframe Offset Select Selects how to specify the subframe offset.

- **Auto.** *Default.* The symbol table is displayed for any offset.
- **STO.** Sets the Subframe to Time-Slot Offset (STO) using the **Subframe to TS Offset** side key.
- **DTO.** Sets the Downlink Time Offset (DTO) using the **Downlink Time Offset** side key.

Subframe to TS Offset Specifies the subframe to time-slot offset when you select **STO** with the **Subframe Offset Select** side key. Range: 0 to 9 symbols (default: 0).

The subframe to time-slot offset is the time offset between the start of the DPDCH time slot and the start of the HS-DPCCH subframe (see Figure 2-16)..

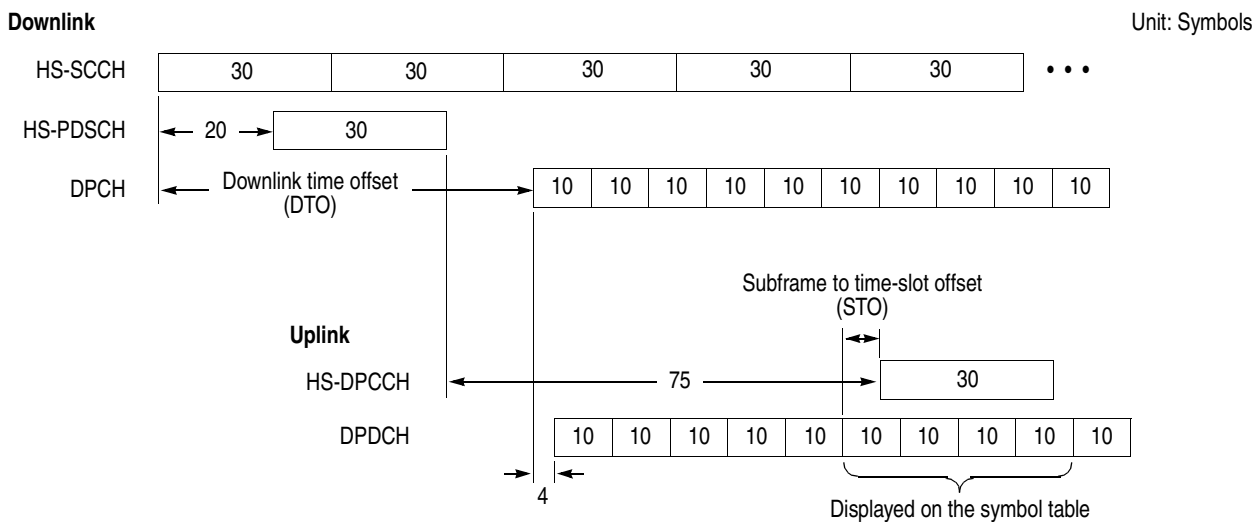

Figure 2-16: Subframe offset

- Downlink Time Offset** Specifies the downlink time offset when you select **DTO** with the **Subframe Offset Select** side key. Range: 0 to 149 symbols (default: 1).
- The downlink time offset is the time offset between the start of HS-SCCH and the start of DPCH (see Figure 2-16)
- Update Timeslot Table** Reanalyzes the existing time slot data to update the table display after you change the subframe offset manually or abort the Analyze (top side key) operation.
- Auto Carrier** Selects whether to detect the carrier automatically.
- **On. Default.** Automatically detects the carrier for every frame. The error from the center frequency is shown on the **Freq Error** side key.
 - **Off.** Sets the carrier frequency using **Frequency Offset**.
- Frequency Offset** Sets the frequency offset when **Auto Carrier** is set to Off. Input the carrier offset from the center frequency.

Display Method for HS-DPCCH

The measurement results for each channel are normally displayed in the view for each time slot. But HS-DPCCH has the different display methods for the settings of Subframe Offset Select in the Meas Setup menu. This section describes how to display HS-DPCCH in each view.

Code Domain Power, Power Codogram, and Code Power versus Time Slot

- *When Subframe Offset Select is set to AUTO*
Each time slot is displayed without offset as the other channels (see the upper part of Figure 2-17).
- *When Subframe Offset Select is set to STO (Subframe to Time slot Offset)*
Each time slot is displayed with offset specified by Subframe to TS Offset in the Meas Setup menu. Also in the total power calculation for the relative value display, only HS-DPCCH is offset in the same way. But the last time slot is displayed without offset (see the lower part of Figure 2-17).
- *When Subframe Offset Select is set to DTO (Downlink Time Offset)*
Each time slot is displayed in the same manner as when Subframe Offset Select is set to STO. But the number of offset symbols is determined by this formula: $[151 - (\text{Downlink Time Offset})] \bmod 10$ (see the lower part of Figure 2-17).

Subframe Offset Select = AUTO

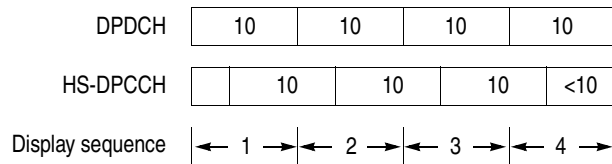

Subframe Offset Select = STO or DTO

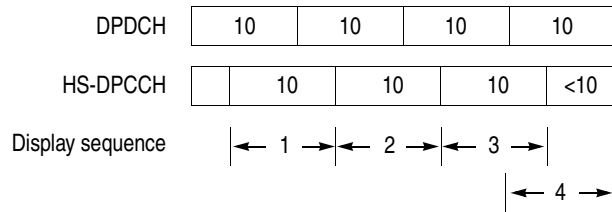

NOTE. "10" in the box represents the number of symbols in a time slot.

Figure 2-17: HS-DPCCH display method

Code Power versus Symbol, Symbol Constellation, Symbol EVM, and Symbol Eye Diagram

- *When Subframe Offset Select is set to AUTO*
10 symbols are displayed for each time slot without offset as the other channels (see the upper part of Figure 2-17 on page 2-36).
- *When Subframe Offset Select is set to STO (Subframe to Time slot Offset)*
30 symbols are displayed for each time slot with offset specified by Subframe to TS Offset in the Meas Setup menu. Also in the total power calculation for the relative value display in the Code power versus Symbol view, only HS-DPCCH is offset in the same way (see the upper part of Figure 2-18). But when there are not enough symbols in the last part of the analysis range, 30, 20, and 10 symbols are displayed without offset as shown in the upper part of Figure 2-18, the display sequence 8, 9, and 10, respectively.
- *When Subframe Offset Select is set to DTO (Downlink Time Offset)*
If the specified time slot is the first one in the subframe, symbols are displayed in the same manner as when Subframe Offset Select is set to STO. Otherwise symbols are displayed in the same manner as when Subframe Offset Select is set to AUTO (see the lower part of Figure 2-17).

Subframe Offset Select = STO

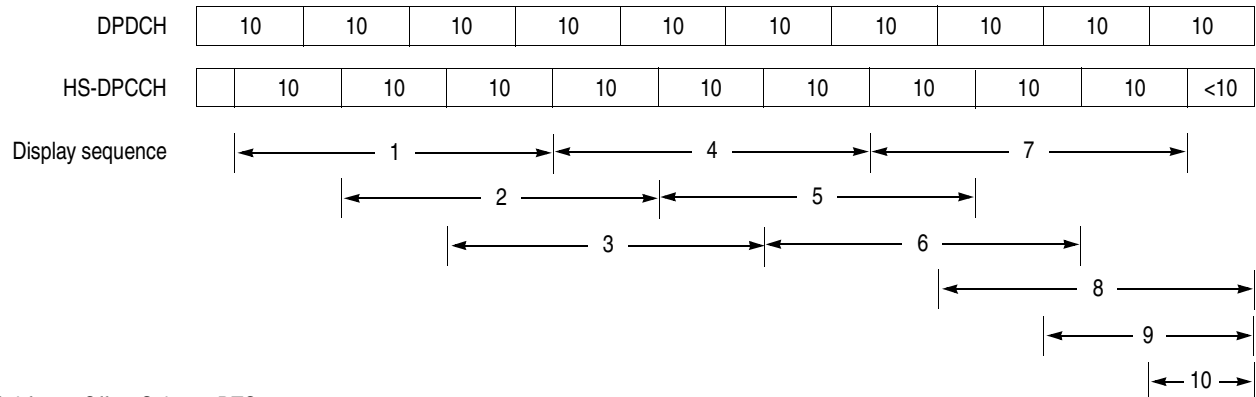

Subframe Offset Select = DTO

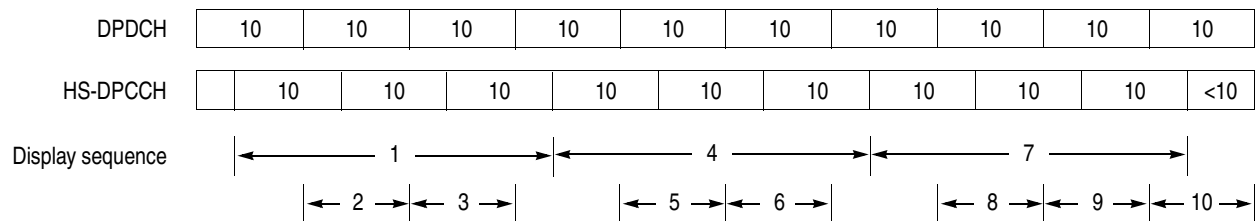

NOTE. "10" in the box represents the number of symbols in a time slot.

Figure 2-18: HS-DPCCH display method

Symbol Table

Symbols of four time slots (40 symbols) are displayed without offset (see the upper part of Figure 2-19). But for the last three time slots, 30, 20, and 10 symbols are displayed without offset as shown in the Figure 2-19, the display sequence 4, 5, and 6, respectively.

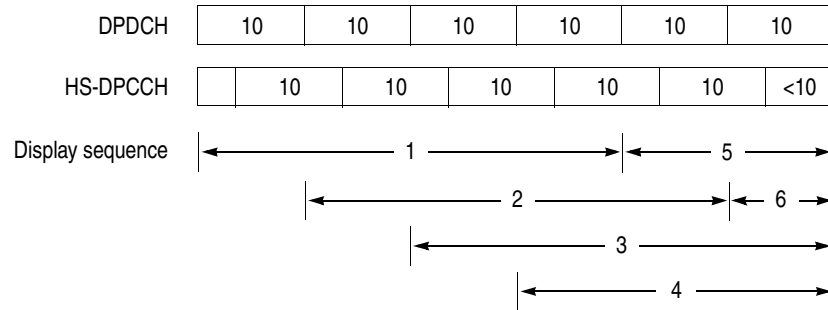

NOTE. "10" in the box represents the number of symbols in a time slot.

Figure 2-19: HS-DPCCH display method (symbol table)

Scale and Format of View

The following main views are specific for the measurement items of the 3GPP-R6 uplink analysis in Demod mode:

- Code domain power
- Power codogram
- Code power versus Time slot
- Code power versus Symbol
- Symbol constellation
- Symbol EVM
- Symbol eye diagram
- Symbol table
- Modulation accuracy
- Modulation accuracy versus Time slot
- Gain ratio

The scale and format of view are controlled by the View menu. This section describes the View: Define menu and the View: Scale menu for each view.

View: Define Menu The View: Define menu is common to all main views of the 3GPP-R6 uplink measurement items. It contains the following controls:

Show Views. Selects the view style:

- **Single.** Displays only the view selected by the VIEW: **SELECT** key.
- **Multi.** *Default.* Displays the overview, subview, and main view.

Overview Content... Selects a view to display in the overview:

- Waveform (power versus time)
- Spectrogram

Subview Content... Selects a view to display in the subview:

- Spectrum
- Code Domain Power
- Power Codogram
- CDP vs Time Slot (Code Domain Power versus Time Slot)
- CDP vs Symbol (Code Domain Power versus Symbol)
- Symbol Constellation
- Symbol EVM
- Symbol Eye Diagram
- Symbol Table
- Modulation Accuracy

Time Slot. Sets a time-slot number to position the marker.

Range: $-[(\text{the number of time slots in the analysis range}) - 1]$ to 0.

Zero (0) represents the latest slot.

Symbol Rate... Sets the symbol rate to display symbol constellation:

- 1920 k
- 960 k
- 480 k
- 240 k
- 120 k
- 60 k
- 30 k
- 15 k
- Composite

The default is Composite for multi-rate.

Channel Number. Selects a channel to position the marker when the View Format is set to Channel. Range: Channel 0 to 12.

Channelization Code. Selects a channelization code to position the marker when the View Format is set to I/Q Split. Range: Channel 0 to 255.

I/Q Branch. Selects the I/Q branch when the View Format is set to I/Q Split.

- **I.** Displays the measurement result for the I branch.
- **Q.** Displays the measurement result for the Q branch.
- **I/Q.** Displays the measurement result for both I and Q branches.

When the View Format is set to Channel, the I/Q Branch is set to Auto, indicating that the I/Q branch is automatically determined.

View Format. Selects the view format (see Figure 2-20).

- **Channel.** Displays the measurement result for the channels of 0 to 12. Table 2-4 shows the channel number and the corresponding channel.

Table 2-4: Channel number

Channel number	Channel name
0	DPCCH
1 to 6	DPDCH
7	HS-DPCCH
8	E-DPCCH
9 to 12	E-DPDCH

Use the **Channel Number** side key to select the channel to position the marker.

- **I/Q Split.** Displays the measurement result for the I and/or Q branch along with the channelization codes of 0 to 255. Select the branch using the **I/Q Branch** side key. Use the **Channelization Code** side key to select the code to position the marker.

Figure 2-20 shows an example of the View Format setting in the code domain power measurement.

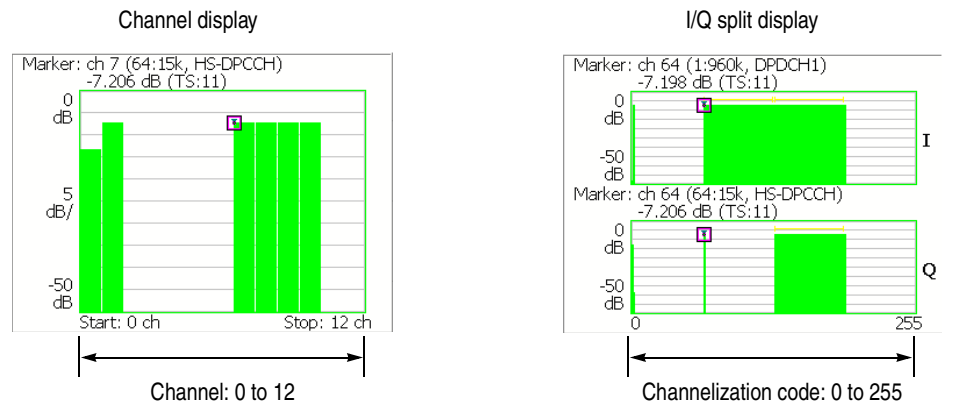

Figure 2-20: View Format setting (code domain power)

Column Items to Display... Turns on or off the column items, as listed in Table 2-5, in the time-slot table.

Table 2-5: Time-slot table contents selection

Column title	Channel	Value
SIG	-	Signature number in the preamble.
PRE	-	Preamble.
TPC	DPCCH	TPC (Transmit Power Control) value.
TFCI	DPCCH	TFCI (Transport Format Combination Indicator) value.
ACK	HS-DPCCH	ACK, NACK, PRE, POST, and DTX.
CQI	HS-DPCCH	CQI (Channel Quality Indicator) value.
Offset	HS-DPCCH	Subframe to Time-slot Offset (STO). Refer to page 2-34.
RSN	E-DPCCH	RSN (Retransmission Sequence Number).
E-TFCI	E-DPCCH	E-TFCI (Enhanced TFCI) value.
Happy	E-DPCCH	Happy bit value.

The time slot table is displayed in the main view, as shown in Figure 2-21, with waveforms and measurement results.

Time slot number in the radio frame

Time slot number in the analysis range (0 is the last)

Select the items to display by pressing VIEW: DEFINE → Column Items to Display (refer to Table 2-5)

	TS	TPC	TFCI	ACK	CQI	Offset
-24	13	1				
-23	14	0				
-22	0	1	1023	POST	27	0
-21	1	1				
-20	2	0				
-19	3	1		POST	27	0
-18	4	0				
-17	5	0				

Figure 2-21: Time slot table (at the lower left of the screen)

Scroll Timeslot Table. Scrolls the time slot table to the right and left.

Menu Off. Turns off the side menu on screen to expand the waveform and measurement result display. Press the **MENU** side key when you return to the original display.

Code Domain Power

When you select Code Domain Power in the Measure menu, the code domain power is displayed for each channel, as shown in Figure 2-22.

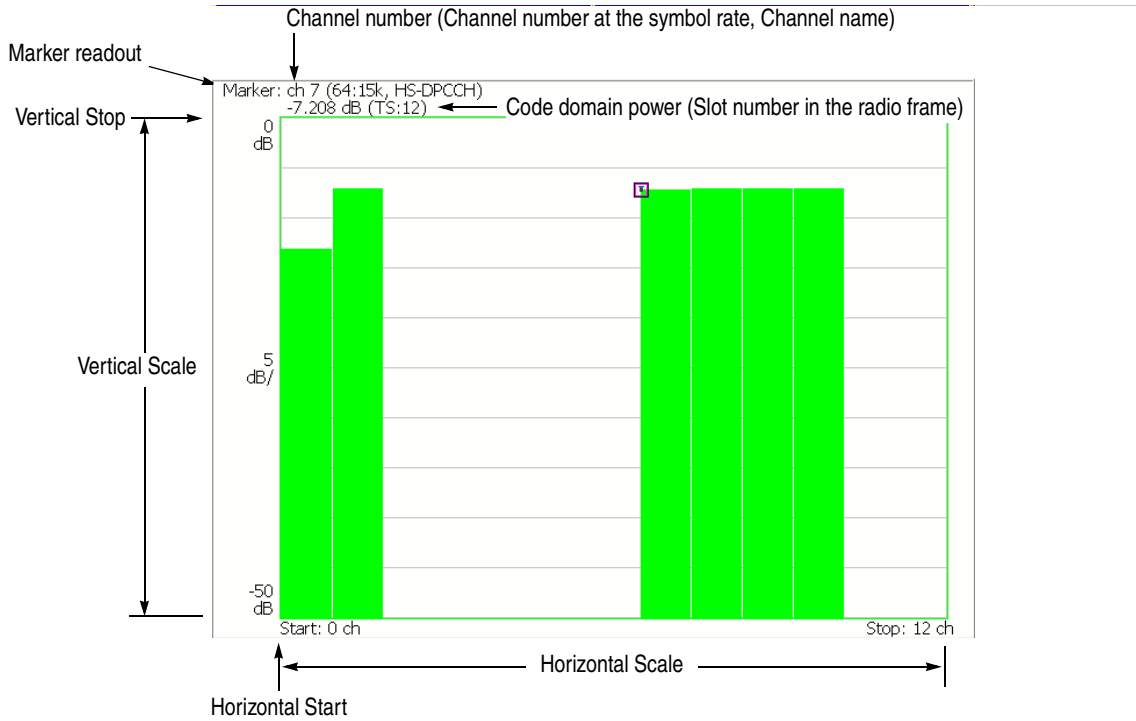

Figure 2-22: Code domain power

View: Scale Menu Use the following controls to scale the view:

Auto Scale. Sets the start value and the scale of the vertical axis automatically to fit the waveform to the screen.

Horizontal Scale. Sets the scale of the horizontal axis.

Range: 1.625 to 13 channels (View Format: Channel)

16 to 256 channels (View Format: I/Q Split)

Refer to page 2-42 for View Format.

Horizontal Start. Sets the start channel number of the horizontal axis.

Range: 0 to [(initial value of Horizontal Scale) – (set value of Horizontal Scale)].

Vertical Scale. Sets the scale of the vertical axis.

Range: 50 μ to 50 dB.

Vertical Stop. Sets the maximum value (top edge) of the vertical axis.

Range: –50 to Vertical Scale [dB].

Full Scale. Sets the scale of the vertical axis to the default full-scale value.

Y Axis. Selects whether to represent the vertical axis (amplitude) with relative or absolute values.

- **Relative.** The vertical axis represents relative power to the reference power selected in the Power Reference menu item.
- **Absolute.** The vertical axis represents absolute power of each channel.

Power Reference... Selects the power reference when Y Axis is set to Relative.

- **Total Power.** Selects the total power of all channels as the reference.
- **DPCCH Power.** Selects the DPCCH power as the reference.

Number of Graphs. Selects the number of graphs in the main view (1 or 2). The number of graphs and display format depend on the settings of View Format and IQ Branch as shown in the table below. For View Format and IQ Branch, refer to pages 2-41 and 2-42.

View Format	I/Q Branch	Number of Graphs	Display format
Channel	-	1 (fixed)	Channel display
I/Q Split	I	1	I branch display
		2	I and Q branches display
	Q	1	Q branch display
		2	I and Q branches display
	I/Q	2 (fixed)	I and Q branches display

Power Codogram

When you select Power Codogram in the Measure menu, the code domain power is displayed in spectrogram, as shown in Figure 2-23.

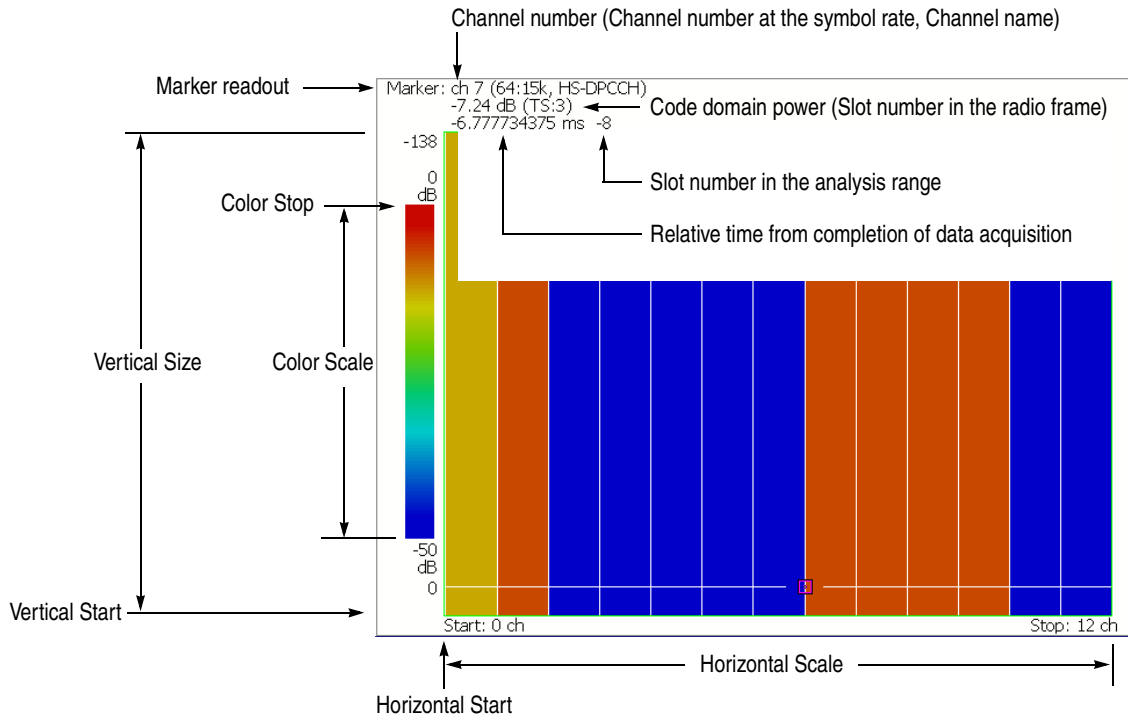

Figure 2-23: Power codogram

View: Scale Menu

Use the following controls to scale the view:

Auto Scale. Sets the start value and the scale of the vertical axis automatically to fit the waveform to the screen.

Horizontal Scale. Sets the scale of the horizontal axis.

Range: 1.625 to 13 channels (View Format: Channel)

16 to 256 channels (View Format: I/Q Split)

Refer to page 2-42 for View Format.

Horizontal Start. Sets the start channel number of the horizontal axis.

Range: 0 to [(initial value of Horizontal Scale) – (set value of Horizontal Scale)].

Vertical Size. Sets the full scale of the vertical axis in frames.

Range: 58 to 59392.

Vertical Start. Sets the start frame number of the vertical axis.

Color Scale. Sets the range of the color axis:

- 5 dB
- 10 dB
- 20 dB
- 50 dB

The spectrogram is displayed in 100 steps (100 colors) from the minimum value (blue) to the maximum value (red) in the default state.

Color Stop. Sets the maximum value (top edge) of the color axis.
Range: -50 to 50 dB.

Full Scale. Sets Color Stop to 0 (zero) and Color Scale to 50 dB.

Y Axis. Selects whether to represent the Y (color) axis with relative or absolute values.

- **Relative.** The Y axis represents relative power to the reference power selected in the Power Reference menu item.
- **Absolute.** The Y axis represents absolute power of each channel.

Power Reference... Selects the power reference when Y Axis is set to Relative.

- **Total Power.** Selects the total power of all channels as the reference.
- **DPCCH Power.** Selects the DPCCH power as the reference.

Number of Graphs. Selects the number of graphs in the main view (1 or 2). The number of graphs and display format depend on the settings of View Format and IQ Branch as shown in the following table. For View Format and IQ Branch, refer to pages 2-41 and 2-42.

View Format	I/Q Branch	Number of Graphs	Display format
Channel	-	1 (fixed)	Channel display
I/Q Split	I	1	I branch display
		2	I and Q branches display
	Q	1	Q branch display
		2	I and Q branches display
	I/Q	2 (fixed)	I and Q branches display

Code Power versus Time Slot

When you select Code Power versus Time Slot in the Measure menu, the code domain power is displayed for each slot, as shown in Figure 2-24.

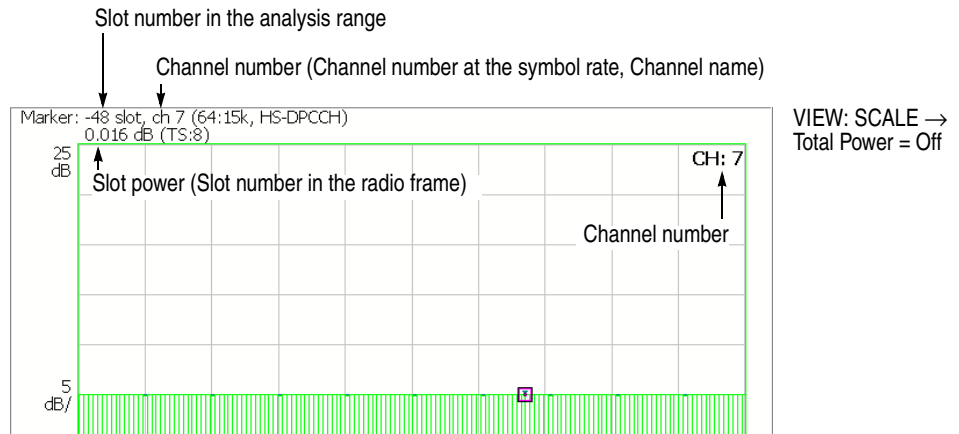
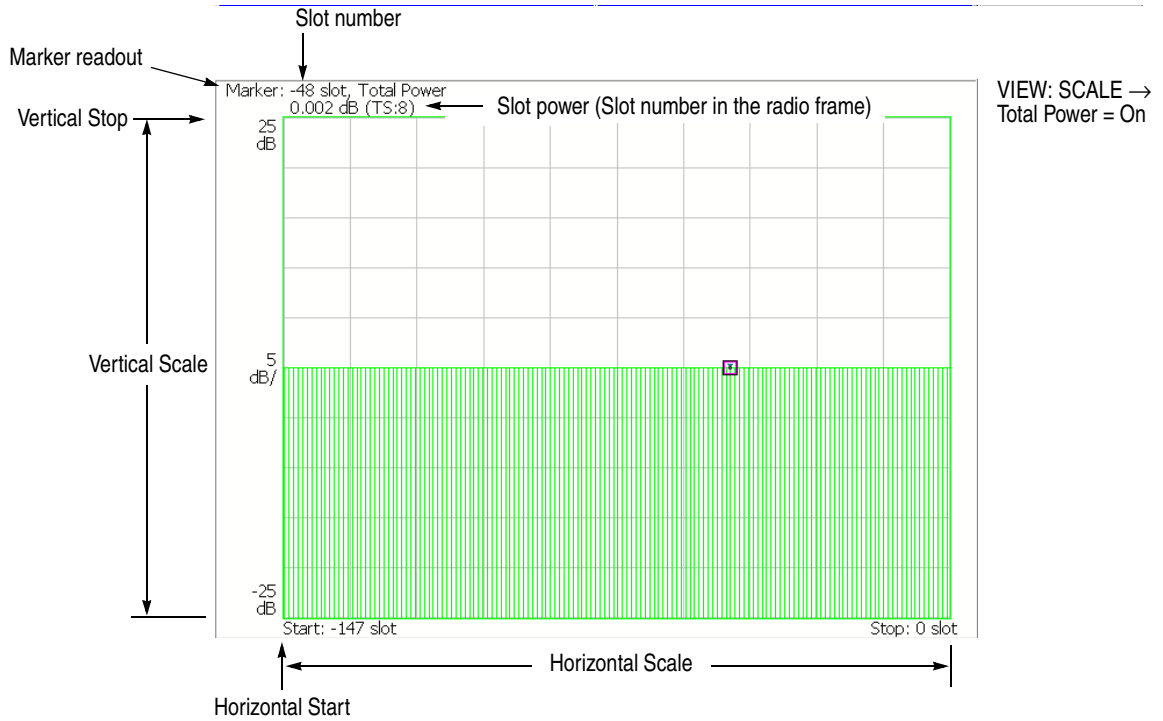

Figure 2-24: Code power versus Time slot

View: Scale Menu

Use the following controls to scale the view:

Auto Scale. Sets the start value and the scale of the vertical axis automatically to fit the waveform to the screen.

Horizontal Scale. Sets the scale of the horizontal axis (number of slots).
Range: $N/8$ to N slots (N : the number of slots in the analysis range.)

Horizontal Start. Sets the start slot number of the horizontal axis.
Range: $-(N - 1)$ to $[1 - (\text{Horizontal Scale})]$.

Vertical Scale. Sets the scale of the vertical axis.
Range: 50μ to 50 dB.

Vertical Stop. Sets the maximum value (top edge) of the vertical axis.
Range: -25 to $[(\text{Vertical Scale}) + 25]$ dB.

Full Scale. Sets the scale of the vertical axis to the default full scale value.

Y Axis. Selects whether to represent the vertical (amplitude) axis with relative or absolute values.

- **Relative.** The vertical axis represents time slot power relative to the power of the first time slot in the analysis range.
- **Absolute.** The vertical axis represents absolute power of time slots.

Total Power. Determines whether to display the total power for each time slot.

- **On. Default.** Displays the total power of all channels for each time slot.
- **Off.** Displays power of the channel specified with Channel Number in the View: Define menu (refer to page 2-40).

Code Power versus Symbol

When you select Code Power versus Symbol in the Measure menu, the code domain power is displayed for each symbol, as shown in Figure 2-25.

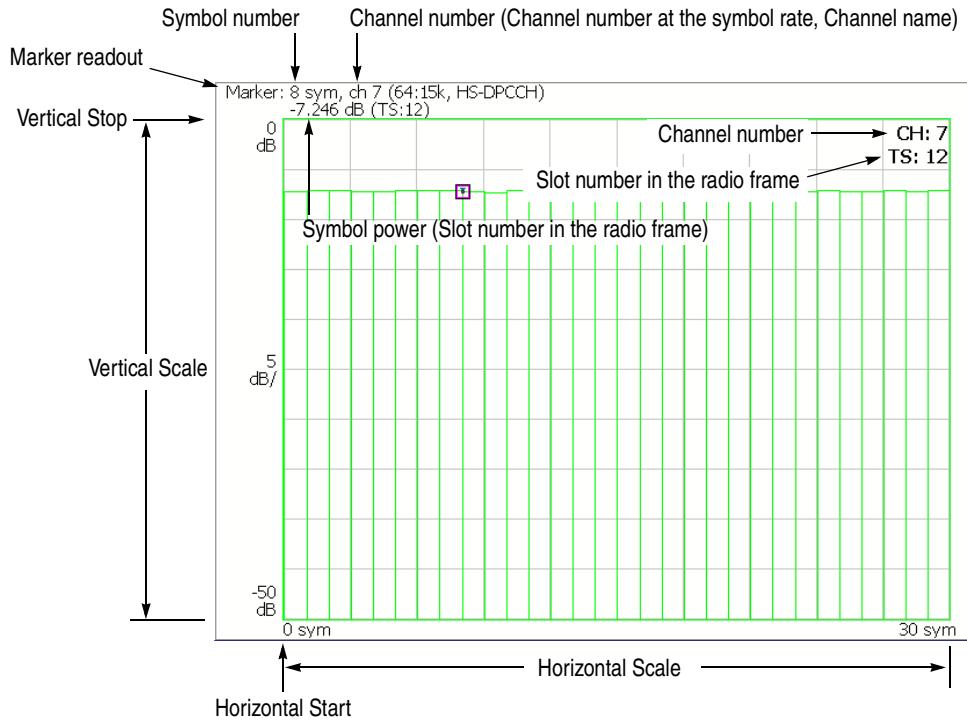

Figure 2-25: Code domain power versus Symbol

View: Scale Menu

Use the following controls to scale the view:

Auto Scale. Sets the start value and the scale of the vertical axis automatically to fit the waveform to the screen.

Horizontal Scale. Sets the scale of the horizontal axis (number of symbols).
Range: 0 to 1280 symbols.

Horizontal Start. Sets the start symbol number of the horizontal axis.
Range: 0 to [(initial value of Horizontal Scale) – (set value of Horizontal Scale)].

Vertical Scale. Sets the scale of the vertical axis.
Range: 50 μ to 50 dB.

Vertical Stop. Sets the maximum value (top edge) of the vertical axis.
Range: –50 to Vertical Scale [dB].

Full Scale. Sets the scale of the vertical axis to the default full-scale value.

Y Axis. Selects whether to represent the vertical (amplitude) axis with relative or absolute values.

- **Relative.** The vertical axis represents relative power to the reference power selected in the Power Reference menu item.
- **Absolute.** The vertical axis represents absolute power of each channel.

Power Reference... Selects the power reference when Y Axis is set to Relative.

- **Total Power.** Selects the total power of all channels as the reference.
- **DPCCH Power.** Selects the DPCCH power as the reference.

Symbol Constellation

The symbol constellation is displayed when you select Symbol Constellation in the Measure menu, as shown in Figure 2-26..

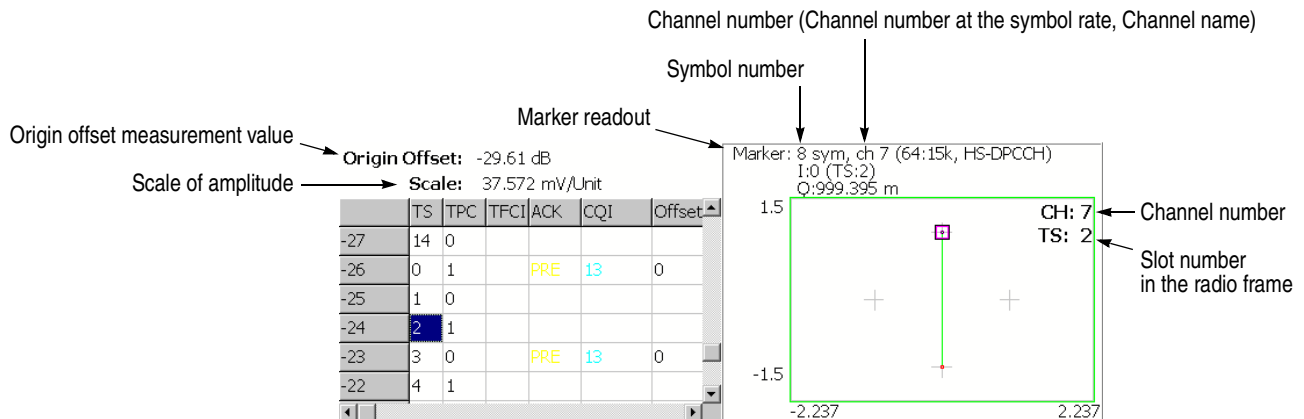

Figure 2-26: Symbol constellation

View: Scale Menu

Use the following controls to set the scale:

Measurement Content... Selects vector or constellation display.

- **Vector.** Selects vector display. A signal represented by phase and amplitude is displayed in polar coordinate or IQ diagram. The red point indicates the symbol position of the measured signal, and the yellow trace indicates the locus of the signal between symbols.
- **Constellation.** Selects constellation display. It is the same as the vector display, except that only symbols of the measured signal are indicated in red, and the locus between symbols is not shown. The cross marks indicate the symbol positions of an ideal signal.

IQ Composite. Selects whether or not to display IQ composite. This setting is effective when you select **VIEW: DEFINE** → **View Format** → **Channel**. Specify the channel using **Channel Number**. (Refer to page 2-41 and 2-42.)

- **On.** Displays IQ composite of the specified channel and other channel(s) transmitted simultaneously.
- **Off. Default.** Displays the I or Q component only for the specified channel.

You can select degree or radian for the angular unit by pressing **SYSTEM** → **Instrument Setup...** → **Angular Units...**

Symbol EVM

When you select Symbol EVM in the Measure menu, EVM (Error Vector Magnitude) is displayed for each symbol, as shown in Figure 2-27.

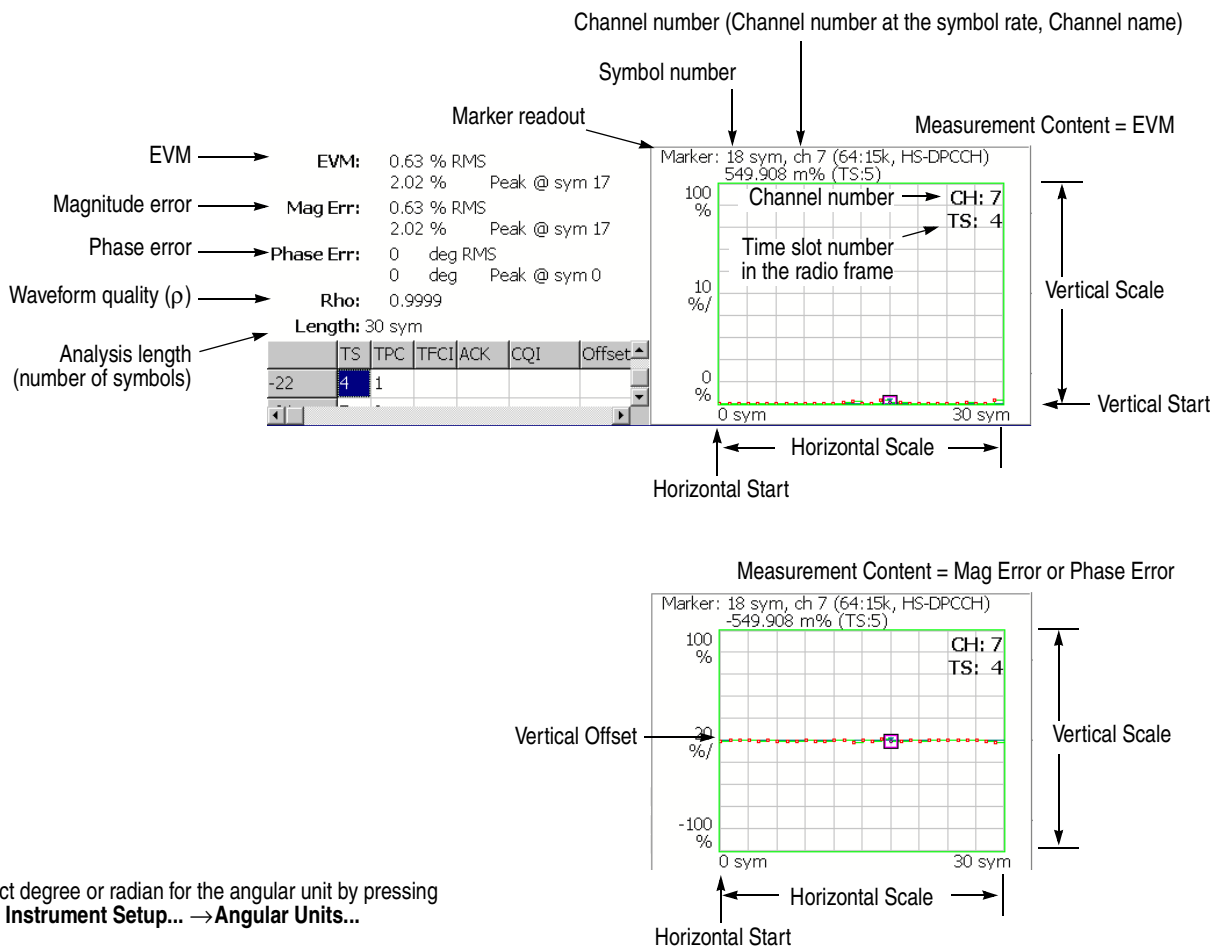

You can select degree or radian for the angular unit by pressing **SYSTEM** → **Instrument Setup...** → **Angular Units...**

Figure 2-27: Symbol EVM

NOTE. For the symbol EVM, the measurement results of EVM, magnitude and phase error are calculated and displayed with EVM IQ Origin Offset (refer to page 2-34) set to Include even if you set it to Exclude.

When the Measurement Content (refer to page 2-54) is Phase Error, the measurement results are not displayed if you set as follows:

- View Format to IQ Split and I/Q Branch to I or Q
- View Format to Channel and I/Q Composite to Off

For View Format and IQ Split, refer to pages 2-41 and 2-42.

For I/Q Composite, refer to page 2-54.

View: Scale Menu

Use the following controls to scale the view:

Auto Scale. Sets the start value and the scale of the vertical axis automatically to display the entire waveform.

Horizontal Scale. Sets the scale of the horizontal axis (number of symbols).
Range: 0 to 1280 symbols.

Horizontal Start. Sets the start symbol number of the horizontal axis.
Range: 0 to [(initial value of Horizontal Scale) – (set value of Horizontal Scale)].

Vertical Scale. Sets the scale of the vertical axis.

Vertical Start. Sets the minimum value (bottom edge) of the vertical axis when the measurement content is EVM. Refer to Table 2-6 for the setting range.

Vertical Offset. Sets the center value ((maximum + minimum) / 2) of the vertical axis when the measurement content is Mag Error or Phase Error. Refer to Table 2-6 for the setting range.

Full Scale. Sets the scale of vertical axis to the default full-scale value.

Measurement Content... Selects the parameter for the vertical axis.
(Refer to Table 2-6.)

- **EVM.** Represents the vertical axis with EVM (Error Vector Magnitude).
- **Mag Error.** Represents the vertical axis with magnitude error.
- **Phase Error.** Represents the vertical axis with phase error.

Table 2-6: Vertical scale setting range, Symbol EVM

Measurement Content...	Vertical Scale	Vertical Start	Vertical Offset
EVM	100μ to 100%	-100 to 100%	-
Mag Error	200μ to 200%	-	-200 to 200%
Phase Error	450μ to 450°	-	-450 to 450°

IQ Composite. Selects whether or not to display IQ composite. This setting is effective when you select **VIEW: DEFINE** → **View Format** → **Channel**. Specify the channel using **Channel Number**. (Refer to page 2-41 and 2-42.)

- **On.** Displays IQ composite of the specified channel and other channel(s) transmitted simultaneously.
- **Off. Default.** Displays the I or Q component only for the specified channel.

Symbol Eye Diagram

The symbol eye diagram is displayed when you select Symbol Eye Diagram in the Measure menu, as shown in Figure 2-28.

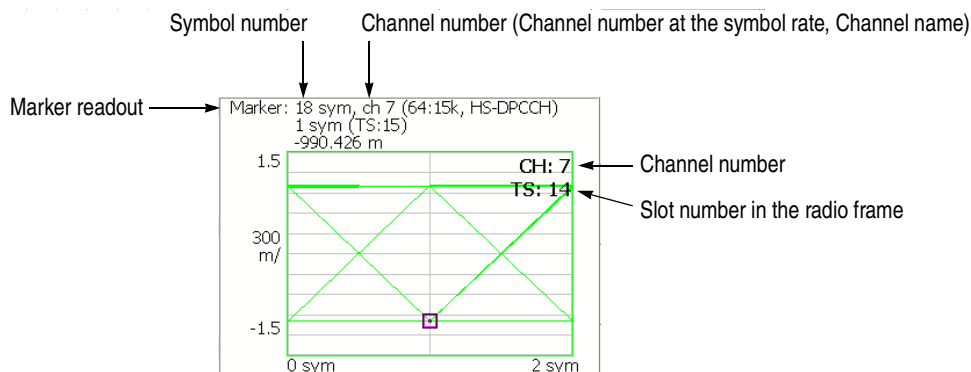

Figure 2-28: Symbol eye diagram

View: Scale Menu

Use the following controls to scale the view.

Measurement Content... Selects the vertical axis of eye diagram.

NOTE. The measurement content is automatically selected in the uplink analysis.

- **I.** Displays I data on the vertical axis.
- **Q.** Displays Q data on the vertical axis.
- **Trellis.** Displays phase on the vertical axis.

The Measurement Content depends on the settings of View Format and I/Q Branch as shown in the table below. For View Format and IQ Branch, refer to pages 2-41 and 2-42

View Format	I/Q Branch	Measurement Content
Channel	-	Determined automatically for each channel.
I/Q Split	I	I (fixed)
	Q	Q (fixed)
	I/Q	Trellis (fixed)

Eye Length. Enters the number of display symbols on the horizontal axis.
Range: 1 to 16 (default: 2)

Symbol Table

The symbol table is displayed when you select Symbol Table in the Measure menu, as shown in Figure 2-29.

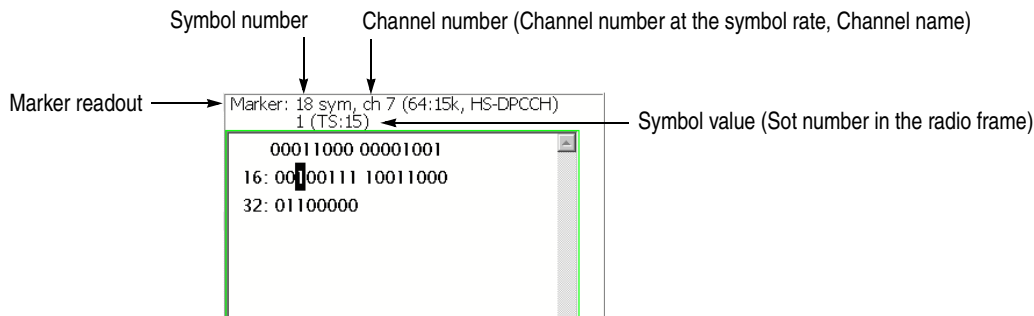

Figure 2-29: Symbol table

When the TS index is changed to a time slot that does not contain the beginning of an HS-DPCCH subframe, the symbol table text is all white. When an ACK or NACK time slot is selected, the symbol table text color changes to show the position of the ACK/NACK symbols (yellow) and the CQI symbols (blue).

NOTE. For the uplink symbol table, the measurement results are not displayed when you set View Format to IQ Split and I/Q Branch to I/Q. (For View Format and IQ Split, refer to pages 2-41 and 2-42.)

View: Scale Menu

Use the following controls to scale the view:

Radix. Selects the radix for displaying the table:

- **Hex (packed).** Displays data in the hexadecimal form every 4 bits.
- **Hex.** Displays data in the hexadecimal form every modulation symbol.
- **Oct.** Displays data in the octal form every modulation symbol.
- **Bin.** *Default.* Displays data in the binary form.

Hex and Oct indicate values of binary data string in units of modulation symbol. When a signal contains one or two-bit data in a symbol, you can select Hex (packed) to represent multiple symbols as a hexadecimal digit every 4 bits. For example, the BPSK modulation signal contains one-bit data in a symbol, so the symbol table has the same values for Hex, Oct, and Bin. But Hex (packed) represents every 4 symbols as a hexadecimal digit.

Rotate. Sets the start position. Range: 0 to 3.

Modulation Accuracy

When you select Modulation Accuracy in the Measure menu, the constellation of all channels before the de-spread is displayed with the measurement results of PCDE (Peak Code Domain Error), EVM, frequency error and others.

When you press the VIEW: **SELECT** key on the front panel to select the constellation view, the measurement results for the time slot are displayed instead of the overview, as shown in Figure 2-30.

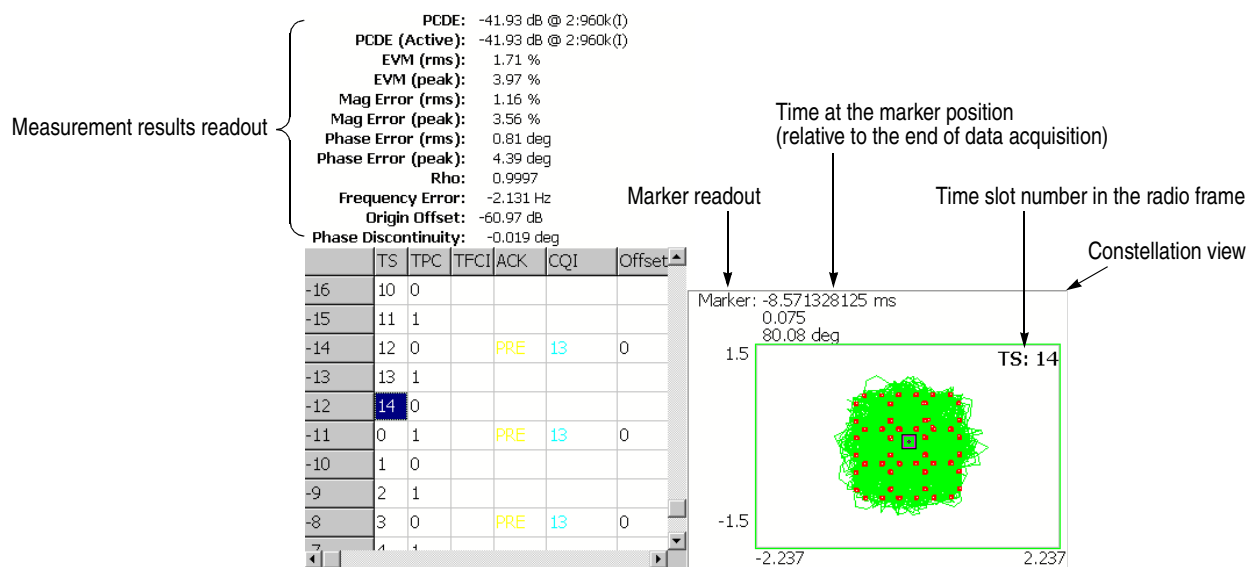

Figure 2-30: Modulation accuracy

The following table shows the measurement results readout.

Measurement results	Description
PCDE	PCDE [dB] @ channel: symbol rate (I/Q)
PCDE (Active)	PCDE [dB] for active channels only @ channel: symbol rate (I/Q)
EVM (rms)	RMS value of EVM [%]
(Peak)	Peak value of EVM [%]
Mag Error (rms)	RMS value of magnitude error [%]
(Peak)	Peak value of magnitude error [%]
Phase Error (rms)	RMS value of phase error [degrees or radians]
(Peak)	Peak value of phase error [degrees or radians]
Rho	Waveform quality (ρ)
Frequency Error	Frequency error [Hz]
Origin Offset	Origin offset (IQ feedthrough) [dB]
Phase Discontinuity	Phase difference between the beginning of the currently selected time slot and the end of the previous time slot.

View: Scale Menu Use the following controls to set the scale:

Measurement Content... Selects vector or constellation display.

- **Vector.** Selects vector display. A signal represented with phase and amplitude is displayed in polar coordinate or IQ diagram. The red point indicates the symbol position of measured signal, and the yellow trace indicates the locus of the signal between symbols.
- **Constellation.** Selects constellation display. It is the same as the vector display, except that only symbols of measured signal are indicated in red, and the locus between symbols is not shown. The cross marks indicate the symbol positions of an ideal signal.

You can select degree or radian for the angular unit by pressing **SYSTEM**
→ **Instrument Setup...** → **Angular Units...**

Modulation Accuracy versus Time Slot

The Modulation accuracy versus Time slot measurement displays EVM, magnitude error, phase error, PCDE (Peak Code Domain Error), or Frequency error for each time slot in the main view. Figure 2-31 shows an example of EVM (rms).

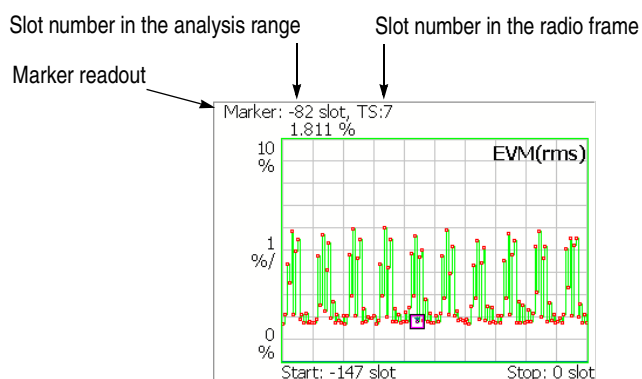

Figure 2-31: Modulation accuracy versus Time slot, EVM (rms)

View: Scale Menu Use the following controls to scale the view.

Auto Scale. Sets the start value and the scale of the vertical axis automatically to fit the waveform to the screen.

Horizontal Scale. Sets the range of the horizontal axis (number of time slots). Range: 18.5 to 148 slots.

Horizontal Start. Sets the start symbol number of the horizontal axis. Range: -147 to $[1 - (\text{Horizontal Scale})]$.

Vertical Scale. Sets the scale of the vertical axis. Refer to Table 2-7 for the setting range.

Vertical Start. Sets the minimum value (bottom edge) of the vertical axis when the measurement content is EVM. Refer to Table 2-7 for the setting range.

Vertical Stop. Sets the maximum value (top edge) of the vertical axis when the measurement content is PCDE. Refer to Table 2-7 for the setting range.

Vertical Offset. Sets the center value $((\text{maximum} + \text{minimum}) / 2)$ of the vertical axis when the measurement content is Mag Error or Phase Error. Refer to Table 2-7 for the setting range.

Full Scale. Sets the scale of vertical axis to the default full-scale value.

Measurement Content... Selects the measurement content (refer to Table 2-7).

Table 2-7: Vertical scale setting range, Modulation accuracy versus Time slot

Measurement Content...	Vertical Scale	Vertical Start	Vertical Stop	Vertical Offset
EVM (rms)	100 μ to 100%	-100 to 100%	-	-
EVM (peak)	100 μ to 100%	-100 to 100%	-	-
Mag Error (rms)	200 μ to 200%	-	-	-200 to 200%
Mag Error (peak)	200 μ to 200%	-	-	-200 to 200%
Phase Error (rms)	450 μ to 450°	-	-	-450 to 450°
Phase Error (peak)	450 μ to 450°	-	-	-450 to 450°
PCDE (Peak Code Domain Error)	100 μ to 100 dB	-	-100 to 100 dB	-
Frequency Error	10 m to 10 kHz	-	-	-10 k to 10 kHz

You can select degree or radian for the angular unit by pressing **SYSTEM**
 → **Instrument Setup...** → **Angular Units...**

Gain Ratio

The Gain Ratio measurement displays the gain ratio (the ratio of channel power to total power) for each channel along with time slots as shown in Figure 2-32. The measurement results are color-coded for each channel. The height of a color band at a given slot number represents the gain ratio of the corresponding channel at that slot. On the left side of the main view, the color assignment and the β value (relative channel power to DPCCH or DPDCH power whichever are greater as the reference value (1)) are indicated for each channel.

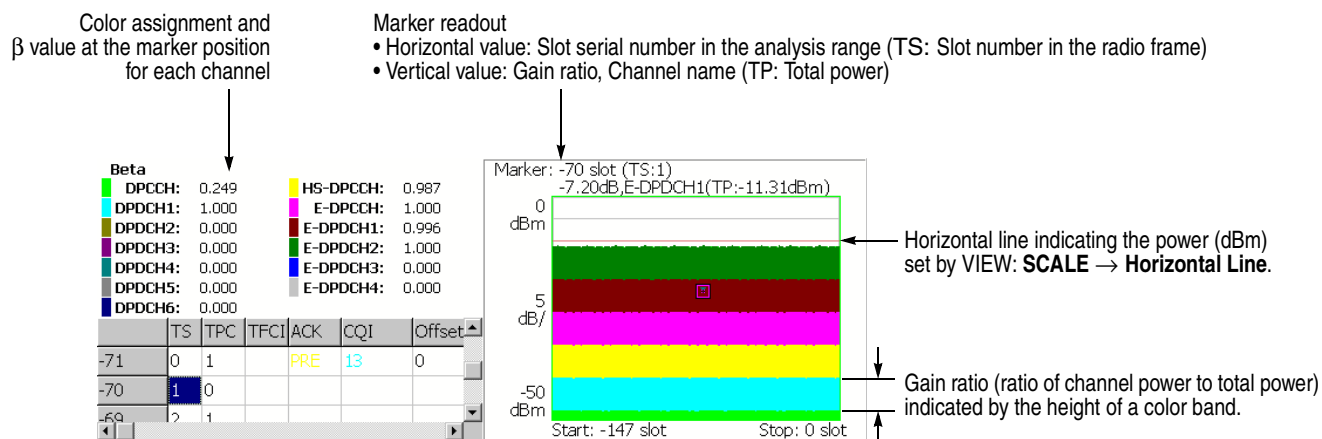

Figure 2-32: Gain ratio

View: Scale Menu Use the following controls to scale the view.

Auto Scale. Sets the start value and the scale of the vertical axis automatically to fit the waveform to the screen.

Horizontal Scale. Sets the scale of the horizontal axis (number of slots). Range: $N/8$ to N slots (N : the number of slots in the analysis range.)

Horizontal Start. Sets the start slot number of the horizontal axis. Range: $-(N - 1)$ to $[1 - (\text{Horizontal Scale})]$.

Vertical Scale. Sets the scale of the vertical axis. Range: 50μ to 50 dB .

Vertical Stop. Sets the maximum value (top edge) of the vertical axis. Range: -52 to $[(\text{Vertical Scale}) - 2] \text{ dBm}$.

Full Scale. Sets the scale of vertical axis to the default full-scale value.

Horizontal Line. Sets the horizontal line position. Range: -100 to 30 dBm .



Syntax and Commands

Command Groups

This section lists the commands added in Option 40 in two ways. It first presents them by functional groups. It then lists them alphabetically. The functional group list starts below. The alphabetical list provides more detail on each command and starts on page 3-7.

For details on the standard analyzer commands, refer to the *WCA230A and WCA280A Programmer Manual* (Tektronix part number 071-1255-xx).

NOTE. *The GPIB commands for the WCA200 Series analyzer are based on SCPI Version 1999.0. However, all commands for the WCA230A/WCA280A Option 40 are not defined in the standard.*

Items followed by question marks are queries; items without question marks are commands. Some items in this section have a question mark in parentheses(?) in the command header section; this indicates that the item can be both a command and a query.

Each command may be available or unavailable, depending on the current measurement mode. The Measurement Modes in each command description shows the measurement mode in which the command is available. To set the measurement mode, use the :INSTrument[:SElect] command (refer to the *WCA230A and WCA280A Programmer Manual*) using one of the mnemonics listed below:

Table 3-1: Measurement modes added in Option 40

Mnemonic	Meaning
DEMDLR6_3G	3GPP-R6 downlink modulation analysis
DEMULR6_3G	3GPP-R6 uplink modulation analysis

Functional Groups

The commands added in Option 40 are divided into the groups listed below.

Table 3-2: List of command groups

Command group	Function
:CONFigure	Configure the analyzer for each measurement session.
:DISPlay	Control how to show waveform and measurement result on the screen.
:FETCh	Retrieve the measurements from the data last acquired.
:MMEMory	Control file saving/loading to/from the hard disk or floppy disk.
:SENSe	Set up detailed conditions for each measurement.

The following sections list the commands by group.

:CONFigure Commands

Set up the analyzer in order to perform the specified measurement.

Table 3-3: :CONFigure commands

Header	Description
:CONFigure:DLR6_3GPP	Sets the analyzer for the modulation analysis in 3GPP-R6 downlink.
:CONFigure:ULR6_3GPP	Sets the analyzer for the modulation analysis in 3GPP-R6 uplink.

:DISPlay Commands

Control how to show measurement data on the screen.

Table 3-4: :DISPlay commands

Header	Description
:DISPlay:DLR6_3GPP subgroup	Related to modulation analysis for 3GPP-R6 downlink
:DISPlay:DLR6_3GPP:AView:CCODE(?)	Sets the channelization code to position the marker.
:DISPlay:DLR6_3GPP:AView:MSLot:HEAD(?)	Sets the number of the head of the time slot to be displayed.
:DISPlay:DLR6_3GPP:AView:MSLot[:STATE](?)	Determines whether to display the multiple or the single slot.
:DISPlay:DLR6_3GPP:AView:RESult:AGScope(?)	Determines whether to show the Absolute Grant Scope in the table.
:DISPlay:DLR6_3GPP:AView:RESult:AGValue(?)	Determines whether to show Absolute Grant Value in the table.
:DISPlay:DLR6_3GPP:AView:RESult:ANACK?	Determines whether to show ACK/NACK in the table.
:DISPlay:DLR6_3GPP:AView:RESult:RGRant(?)	Determines whether to show Relative Grant Value in the table.
:DISPlay:DLR6_3GPP:AView:RESult:SCGRoup(?)	Determines whether to show Relative Grant Value in the table.
:DISPlay:DLR6_3GPP:AView:RESult:SCNumber(?)	Determines whether to show Scrambling Code Number in the table.
:DISPlay:DLR6_3GPP:AView:RESult:SSCH(?)	Determines whether to show S-SCH in the table.
:DISPlay:DLR6_3GPP:AView:SRATe(?)	Selects the symbol rate for downlink analysis.
:DISPlay:DLR6_3GPP:AView:SSCHpart(?)	Determines whether to show SCH.
:DISPlay:DLR6_3GPP:AView:TSLot(?)	Selects the time slot to display.
:DISPlay:DLR6_3GPP:MView SVIew:COLor[:SCALE]:OFFSet(?)	Sets the minimum color-axis value (bottom end) in the main view.
:DISPlay:DLR6_3GPP:MView SVIew:COLor[:SCALE]:RANGe(?)	Sets the color-axis full scale in the main view.
:DISPlay:DLR6_3GPP:MView SVIew:FORMat(?)	Selects the main view display format.
:DISPlay:DLR6_3GPP:MView SVIew:RADix(?)	Selects the base of symbols in the main view.
:DISPlay:DLR6_3GPP:MView SVIew:X[:SCALE]:OFFSet(?)	Sets the minimum horizontal value (left end) in the main view.
:DISPlay:DLR6_3GPP:MView SVIew:X[:SCALE]:RANGe(?)	Sets the horizontal full scale in the main view.
:DISPlay:DLR6_3GPP:MView SVIew:Y[:SCALE]:FIT	Runs auto-scale on the main view.
:DISPlay:DLR6_3GPP:MView SVIew:Y[:SCALE]:FULL	Sets the main view's vertical axis to the default full scale.

Table 3-4: :DISPlay commands (cont.)

Header	Description
:DISPlay:DLR6_3GPP:MVlew :SVlew:Y[:SCALe]:OFFSet(?)	Sets the minimum vertical value (bottom end) in the main view.
:DISPlay:DLR6_3GPP:MVlew :SVlew:Y[:SCALe]:PUNit(?)	Selects the unit for the main view's vertical axis.
:DISPlay:DLR6_3GPP:MVlew :SVlew:Y[:SCALe]:RANGe(?)	Sets the vertical full scale in the main view.
:DISPlay:ULR6_3GPP subgroup	Related to modulation analysis for 3GPP-R6 uplink
:DISPlay:ULR6_3GPP:AVlew:CCODE(?)	Sets the channelization code to position the marker.
:DISPlay:ULR6_3GPP:AVlew:CNUMber(?)	Sets the channelization code to position the marker.
:DISPlay:ULR6_3GPP:AVlew:FORMat(?)	Selects the view format.
:DISPlay:ULR6_3GPP:AVlew:IQBRanch(?)	Selects the I/Q branch.
:DISPlay:DLR6_3GPP:AVlew:RESult:ANACK?	Determines whether to show ACK/NACK in the table.
:DISPlay:DLR6_3GPP:AVlew:RESult:CQI(?)	Determines whether to show CQI in the table.
:DISPlay:DLR6_3GPP:AVlew:RESult:ETFCi(?)	Determines whether to show E-TFCI in the table.
:DISPlay:DLR6_3GPP:AVlew:RESult:HAPPy(?)	Determines whether to show Happy bit value in the table.
:DISPlay:DLR6_3GPP:AVlew:RESult:OFFSet(?)	Determines whether to show Subframe to Time-slot Offset in the table.
:DISPlay:DLR6_3GPP:AVlew:RESult:PREamble(?)	Determines whether to show preamble in the table.
:DISPlay:DLR6_3GPP:AVlew:RESult:RSN(?)	Determines whether to show RSN in the table.
:DISPlay:DLR6_3GPP:AVlew:RESult:SIGNature(?)	Determines whether to show Signature Number in the table.
:DISPlay:DLR6_3GPP:AVlew:RESult:TPC(?)	Determines whether to show TPC in the table.
:DISPlay:ULR6_3GPP:AVlew:SRATe(?)	Selects the symbol rate for uplink analysis.
:DISPlay:ULR6_3GPP:AVlew:TSLot(?)	Selects the time slot to display.
:DISPlay:ULR6_3GPP:MVlew :SVlew:COLor[:SCALe]:OFFSet(?)	Sets the minimum color-axis value (bottom end) in the subview.
:DISPlay:ULR6_3GPP:MVlew :SVlew:COLor[:SCALe]:RANGe(?)	Sets the color-axis full scale in the subview.
:DISPlay:ULR6_3GPP:MVlew :SVlew:FORMat(?)	Selects the min view or subview display format.
:DISPlay:ULR6_3GPP:MVlew :SVlew:NUMBer(?)	Selects the number of graphs displayed.
:DISPlay:ULR6_3GPP:MVlew :SVlew:PREFerence(?)	Selects the power reference.
:DISPlay:ULR6_3GPP:MVlew :SVlew:RADix(?)	Selects the base of symbols in the subview.
:DISPlay:ULR6_3GPP:MVlew :SVlew:X[:SCALe]:LINE(?)	Sets the position of the horizontal line in the gain ratio measurement.
:DISPlay:ULR6_3GPP:MVlew :SVlew:X[:SCALe]:OFFSet(?)	Sets the minimum horizontal value (left end) in the subview.
:DISPlay:ULR6_3GPP:MVlew :SVlew:X[:SCALe]:RANGe(?)	Sets the horizontal full scale in the subview.
:DISPlay:ULR6_3GPP:MVlew :SVlew:Y[:SCALe]:FIT	Runs auto-scale on the subview.
:DISPlay:ULR6_3GPP:MVlew :SVlew:Y[:SCALe]:FULL	Sets the subview's vertical axis to the default full scale.
:DISPlay:ULR6_3GPP:MVlew :SVlew:Y[:SCALe]:OFFSet(?)	Sets the minimum vertical value (bottom end) in the subview.
:DISPlay:ULR6_3GPP:MVlew :SVlew:Y[:SCALe]:PUNit(?)	Selects the unit for the subview's vertical axis.
:DISPlay:ULR6_3GPP:MVlew :SVlew:Y[:SCALe]:RANGe(?)	Sets the vertical full scale in the subview.

:FETCh Commands

The :FETCh commands retrieve the measurements from the data taken by the latest INITiate command.

Table 3-5: :FETCh commands

Header	Description
:FETCh:DLR6_3GPP?	Returns measurement results of the downlink modulation analysis.
:FETCh:ULR6_3GPP?	Returns measurement results of the uplink modulation analysis.

:MMEMory Commands

Use these commands to manipulate files on the hard disk or floppy disk.

Table 3-6: :MMEMory commands

Header	Description
:MMEMory:LOAD:LIMit	Loads the limit from the specified file.
:MMEMory:STORE:LIMit	Stores the limit in the specified file.
:MMEMory:STORE:RESult:ITEM(?)	Selects the measurement item to store.
:MMEMory:STORE:RESult:MCONtent(?)	Selects the measurement content in the symbol EVM measurement.
:MMEMory:STORE:RESult[:SElect]	Stores the measurement results in the specific file.
:MMEMory:STORE:RESult:TSLot:OFFSet(?)	Sets the first time-slot for storing the measurement results.
:MMEMory:STORE:RESult:TSLot:NUMBer(?)	Sets the number of time slots for storing the measurement.
:MMEMory:STORE:STABle	Stores the symbol table in the specified file.

:SENSe Commands

Set the detailed measurement conditions.

Table 3-7: :SENSe commands

Header	Description
[[:SENSe]:DLR6_3GPP subgroup	Related to modulation analysis for 3GPP-R6 downlink
[[:SENSe]:DLR6_3GPP:BLOCK(?)	Sets the number of the block to measure.
[[:SENSe]:DLR6_3GPP:CARRier:OFFSet(?)	Sets the carrier frequency offset.
[[:SENSe]:DLR6_3GPP:CARRier:SEARch(?)	Determines whether to detect the carrier automatically.
[[:SENSe]:DLR6_3GPP:CCODE:e:AGCh(?)	Sets the channelization code number of E-AGCH.
[[:SENSe]:DLR6_3GPP:CCODE:e:RGCh(?)	Sets the channelization code number of E-RGCH and E-HICH.
[[:SENSe]:DLR6_3GPP:COMPosite(?)	Determines whether to perform the composite analysis.
[[:SENSe]:DLR6_3GPP:DTYPE:SEARch(?)	Determines whether to detect the demodulation type of the code channel.
[[:SENSe]:DLR6_3GPP:EVM:IQOffset(?)	Determines whether to include the I/Q origin offset in the analysis.

Table 3-7: :SENSE commands (cont.)

Header	Description
[[:SENSe]:DLR6_3GPP:FILTer:ALPHa(?)]	Sets the filter factor.
[[:SENSe]:DLR6_3GPP:FILTer:MEASurement(?)]	Selects the measurement filter.
[[:SENSe]:DLR6_3GPP:FILTer:REFerence(?)]	Selects the reference filter.
[[:SENSe]:DLR6_3GPP[:IMMEDIATE]]	Runs the 3GPP-R6 downlink analysis calculation on the acquired data.
[[:SENSe]:DLR6_3GPP:LENGth(?)]	Defines the analysis range.
[[:SENSe]:DLR6_3GPP:OFFSet(?)]	Sets the measurement start position.
[[:SENSe]:DLR6_3GPP:SCHPart(?)]	Determines whether to include the SCH part in the analysis.
[[:SENSe]:DLR6_3GPP:SCODE:ALTErnative(?)]	Selects the alternative scrambling code.
[[:SENSe]:DLR6_3GPP:SCODE:NUMBer(?)]	Sets the scrambling code.
[[:SENSe]:DLR6_3GPP:SCODE:SEARCh(?)]	Determines whether to enable automatic detection of the scrambling code.
[[:SENSe]:DLR6_3GPP:CCODE:EAGCh(?)]	Sets the signature sequence index number of E-HICH.
[[:SENSe]:DLR6_3GPP:CCODE:ERGCh(?)]	Sets the signature sequence index number of E-RGCH.
[[:SENSe]:DLR6_3GPP:UTSTable]	Updates the time-slot table.
[[:SENSe]:ULR6_3GPP subgroup]	Related to modulation analysis for 3GPP-R6 uplink.
[[:SENSe]:ULR6_3GPP:BLOCK(?)]	Sets the number of the block to be measured.
[[:SENSe]:ULR6_3GPP:CARRier:OFFSet(?)]	Sets the carrier frequency offset.
[[:SENSe]:ULR6_3GPP:CARRier:SEARCh(?)]	Determines whether to detect the carrier automatically.
[[:SENSe]:ULR6_3GPP:CCONfig(?)]	Selects the channel configuration.
[[:SENSe]:ULR6_3GPP:DFOrmat(?)]	Selects the DPCCH format to decode TFCl.
[[:SENSe]:ULR6_3GPP:EVM:IQOffSet(?)]	Determines whether to include the I/Q origin offset in calculation.
[[:SENSe]:ULR6_3GPP:EVM:TPERiods(?)]	Determines whether to include the transient periods in calculation.
[[:SENSe]:ULR6_3GPP:FILTer:ALPHa(?)]	Sets the filter factor (α /BT).
[[:SENSe]:ULR6_3GPP:FILTer:MEASurement(?)]	Selects the measurement filter.
[[:SENSe]:ULR6_3GPP:FILTer:REFerence(?)]	Selects the reference filter.
[[:SENSe]:ULR6_3GPP[:IMMEDIATE]]	Starts 3GPP-R6 downlink analysis calculation.
[[:SENSe]:ULR6_3GPP:LENGth(?)]	Defines the analysis range.
[[:SENSe]:ULR6_3GPP:OFFSet(?)]	Sets the measurement start position.
[[:SENSe]:ULR6_3GPP:SCODE:NUMBer(?)]	Sets the scrambling code number.
[[:SENSe]:ULR6_3GPP:SCODE:TYPE(?)]	Selects or queries the scrambling code type.
[[:SENSe]:ULR6_3GPP:SFRame:OFFSet:DTIME(?)]	Sets the downlink time offset.
[[:SENSe]:ULR6_3GPP:SFRame:OFFSet[:STSLot](?)	Sets or queries the subframe to time-slot offset.
[[:SENSe]:ULR6_3GPP:SFRame:SEARCh(?)]	Determines whether to detect the subframe offset automatically.
[[:SENSe]:ULR6_3GPP:SFRame:TOLerance(?)]	Sets the tolerance for decoding HS-DPCCH and E-DPCCH.
[[:SENSe]:ULR6_3GPP:THReshold[:BURSt](?)	Sets the threshold level to detect a burst.
[[:SENSe]:ULR6_3GPP:THReshold:DTX(?)]	Sets the threshold level to detect the DTX state.
[[:SENSe]:ULR6_3GPP:UTSTable]	Updates the time-slot table.

:CONFigure Commands

The :CONFigure commands set up the analyzer to the default settings for the specified measurement.

Command Tree

Header	Parameter
:CONFigure	
:DLR6_3GPP	
:ULR6_3GPP	

NOTE. Data acquisition stops on completion of a :CONFigure command. Each command description shows the front-panel key operation equivalent to running the command except the data acquisition control.

:CONFigure:DLR6_3GPP (No Query Form)

Sets the analyzer to the default settings for the 3GPP-R6 downlink modulation measurements. This command is equivalent to the following key sequence:

DEMOD key → **Standard...** side key → **3GPP-R6-DL** side key → **PRESET** key

Syntax :CONFigure:DLR6_3GPP

Arguments None

Measurement Modes DEMDLR6_3G

Examples :CONFigure:DLR6_3GPP
sets the analyzer to the default settings for the 3GPP-R6 downlink modulation measurements.

Related Commands :INSTrument[:SElect]

:CONFigure:ULR6_3GPP (No Query Form)

Sets the analyzer to the default settings of the 3GPP-R6 uplink modulation analysis. This command is equivalent to the following key sequence:

DEMOD key → **Standard...** side key → **3GPP-R6-UL** side key → **PRESET** key

Syntax :CONFigure:ULR6_3GPP

Arguments None

Measurement Modes DEMULR6_3G

Examples :CONFigure:ULR6_3GPP
sets the analyzer to the default settings for the 3GPP-R6 uplink modulation measurements.

Related Commands :INSTrument[:SElect]

:DISPlay Commands

The :DISPlay commands control how to show measurement data on the screen. These commands are divided into the following subgroups:

Table 3-8: :DISPlay command subgroups

Command header	Function	Refer to:
:DISPlay:DLR6_3GPP	Controls display for the 3GPP-R6 downlink modulation analysis.	page 3-10
:DISPlay:ULR6_3GPP	Controls display for the 3GPP-R6 uplink modulation analysis.	page 3-31

NOTE. The :DISPlay commands change the measurement display only, and do not affect the analyzer hardware settings.

:DISPlay:DLR6_3GPP Subgroup

The :DISPlay:DLR6_3GPP commands control display of the 3GPP-R6 downlink modulation analysis.

NOTE. To use a command from this group, you must have selected DEMDLR6_3G (3GPP-R6 downlink modulation analysis) in the :INSTRument[:SElect] command.

Command Tree	Header	Parameter
	:DISPlay	
	:DLR6_3GPP	
	:AVIEW	
	:CCODE	<number>
	:MSLOT	
	:HEAD	<numeric_value>
	[:STATE]	<boolean>
	:RESULT	
	:AGSCOPE	<boolean>
	:AGVALUE	<boolean>
	:ANACK	<boolean>
	:RGRANT	<boolean>
	:SSCH	<boolean>
	:SCGROUP	<boolean>
	:SCNUMBER	<boolean>
	:SRATE	COMPOSITE R960S R480S R240S R120S R60S R30S R15S R7P5S
	:SSCHPART	<boolean>
	:TSLot	<number>
	:MWIEW :SVIEW	
	:COLOR	
	[:SCALE]	
	:OFFSET	<amplitude>
	:RANGE	<relative_amplitude>
	:ELENGTH	<numeric_value>
	:FORMAT	OFF CSGRAM CPCCODE CPSHORTCODE CPSYMBOL CPTSLot SCONSTE SVECTOR SEVM SMERror SPERror SIEYE SQEYE STEYE STABLE CONSTE VECTOR
	:POWER	
	:SElect	CODE PSCH SSCH
	[:TOTAl]	<boolean>
	:RADix	BINARY OCTAl HEXadecimal
	:ROTation	<numeric_value>

```
:X
  [:SCALE]
    :OFFSet <numeric_value>
    :RANGe  <numeric_value>
:Y
  [:SCALE]
    :FIT
    :FULL
    :OFFSet <numeric_value>
    :PUNit  RELative | ABSolute
    :RANGe  <numeric_value>
```

:DISPlay:DLR6_3GPP:AVIew:CCODE(?)

Sets or queries the channelization code to position the marker in the 3GPP-R6 downlink modulation analysis.

Syntax :DISPlay:DLR6_3GPP:AVIew:CCODE <number>
 :DISPlay:DLR6_3GPP:AVIew:CCODE?

Arguments <number> ::= <NR1> specifies the channelization code.
 Range: Channel 0 to 511.

Measurement Modes DEMDLR6_3G

Examples :DISPlay:DLR6_3GPP:AVIew:CCODE 100
 sets the channelization code to 100 to position the marker.

:DISPlay:DLR6_3GPP:AVIew:MSLot:HEAD(?)

Sets or queries the index of the time slot to be displayed at the left edge on the view when :DISPlay:DLR6_3GPP:AVIew:MSLot[:STATe] is On. This function is not supported by local operation.

Syntax :DISPlay:DLR6_3GPP:AVIew:MSLot:HEAD <number>
 :DISPlay:DLR6_3GPP:AVIew:MSLot:HEAD?

Arguments <number> ::= <NR1> specifies the index of the time slot to be displayed at the left edge on the view. Range: -15985 to -14.

When the number of analyzed time slots is 15 or less, this command has no effect on the analyzer setting and the query returns the value of -(the number of analyzed time slots - 1).

Measurement Modes DEMDLR6_3G

Examples :DISPlay:DLR6_3GPP:AVIew:MSLot:HEAD -100
 sets the number of the head of the time slot to -100.

Related Commands :DISPlay:DLR6_3GPP:AVIew:MSLot[:STATe]

:DISPlay:DLR6_3GPP:AVIew:MSLot[:STATe](?)

Determines whether to display the multiple or the single slot.

The multiple slot is valid when :DISPlay:DLR6_3GPP:MVIew:FORMat is set to CPStYmbol, CPRSlot, SEVM, SMERror, SPERror, or CSGRam.

Syntax :DISPlay:DLR6_3GPP:AVIew:MSLot[:STATe]
{ OFF | ON | 0 | 1 }

:DISPlay:DLR6_3GPP:AVIew:MSLot[:STATe]?

Arguments OFF or 0 displays the single slot.

ON or 1 displays the multiple slot. You can specify the index of the time slot to be displayed at the left edge on the view with the :DISPlay:DLR6_3GPP:AVIew:MSLot:HEAD command.

Measurement Modes DEMDLR6_3G

Examples :DISPlay:DLR6_3GPP:AVIew:MSLot:STATe ON
displays the multiple slot.

Related Commands :DISPlay:DLR6_3GPP:AVIew:MSLot:HEAD,
:DISPlay:DLR6_3GPP:MVIew:FORMat

:DISPlay:DLR6_3GPP:AVIew:RESult:AGSCope(?)

Determines whether to show or hide Absolute Grant Scope (E-AGCH) in the time-slot table.

Syntax :DISPlay:DLR6_3GPP:AVIew:RESult:AGSCope
{ OFF | ON | 0 | 1 }

:DISPlay:DLR6_3GPP:AVIew:RESult:AGSCope?

Arguments OFF or 0 hides Absolute Grant Scope in the time-slot table.

ON or 1 shows Absolute Grant Scope in the time-slot table.

Measurement Modes DEMDLR6_3G

Examples :DISPlay:DLR6_3GPP:AVIew:RESult:AGSCope ON
shows Absolute Grant Scope in the time-slot table.

:DISPlay:DLR6_3GPP:AVIew:RESult:AGValue(?)

Determines whether to show or hide Absolute Grant Value (E-AGCH) in the time-slot table.

Syntax :DISPlay:DLR6_3GPP:AVIew:RESult:AGValue
{ OFF | ON | 0 | 1 }

:DISPlay:DLR6_3GPP:AVIew:RESult:AGValue?

Arguments OFF or 0 hides Absolute Grant Value in the time-slot table.

ON or 1 shows Absolute Grant Value in the time-slot table.

Measurement Modes DEMDLR6_3G

Examples :DISPlay:DLR6_3GPP:AVIew:RESult:AGValue ON
shows Absolute Grant Value in the time-slot table.

:DISPlay:DLR6_3GPP:AVIew:RESult:ANACK(?)

Determines whether to show or hide Ack/Nack (E-HICH) in the time-slot table.

Syntax :DISPlay:DLR6_3GPP:AVIew:RESult:ANACK
{ OFF | ON | 0 | 1 }

:DISPlay:DLR6_3GPP:AVIew:RESult:ANACK?

Arguments OFF or 0 hides ACK/NACK (E-HICH) in the time-slot table.

ON or 1 shows ACK/NACK (E-HICH) in the time-slot table.

Measurement Modes DEMDLR6_3G

Examples :DISPlay:DLR6_3GPP:AVIew:RESult:ANACK ON
shows ACK/NACK (E-HICH) in the time-slot table.

:DISPlay:DLR6_3GPP:AVIew:RESult:RGRant(?)

Determines whether to show or hide Relative Grant Value (E-RGCH) in the time-slot table.

Syntax :DISPlay:DLR6_3GPP:AVIew:RESult:RGRant
{ OFF | ON | 0 | 1 }

:DISPlay:DLR6_3GPP:AVIew:RESult:RGRant?

Arguments OFF or 0 hides Relative Grant Value in the time-slot table.

ON or 1 shows Relative Grant Value in the time-slot table.

Measurement Modes DEMDLR6_3G

Examples :DISPlay:DLR6_3GPP:AVIew:RESult:RGRant ON
shows Relative Grant Value in the time-slot table.

:DISPlay:DLR6_3GPP:AVIew:RESult:SCGRoup(?)

Determines whether to show or hide SCG (Scrambling Code Group) in the time-slot table.

Syntax :DISPlay:DLR6_3GPP:AVIew:RESult:SCGRoup
{ OFF | ON | 0 | 1 }

:DISPlay:DLR6_3GPP:AVIew:RESult:SCGRoup?

Arguments OFF or 0 hides SCG in the time-slot table.

ON or 1 shows SCG in the time-slot table.

Measurement Modes DEMDLR6_3G

Examples :DISPlay:DLR6_3GPP:AVIew:RESult:SCGRoup ON
shows SCG in the time-slot table.

:DISPlay:DLR6_3GPP:AVIew:RESult:SCNumber(?)

Determines whether to show or hide Relative Grant Value (E-RGCH) in the time-slot table.

Syntax :DISPlay:DLR6_3GPP:AVIew:RESult:SCNumber
{ OFF | ON | 0 | 1 }

:DISPlay:DLR6_3GPP:AVIew:RESult:SCNumber?

Arguments OFF or 0 hides SCN in the time-slot table.

ON or 1 shows SCN in the time-slot table.

Measurement Modes DEMDLR6_3G

Examples :DISPlay:DLR6_3GPP:AVIew:RESult:SCNumber ON
shows SCN in the time-slot table.

:DISPlay:DLR6_3GPP:AVIew:RESult:SSCH(?)

Determines whether to show or hide S-SCH (Secondary Synchronization Channel) in the time-slot table.

Syntax :DISPlay:DLR6_3GPP:AVIew:RESult:SSCH
{ OFF | ON | 0 | 1 }

:DISPlay:DLR6_3GPP:AVIew:RESult:SSCH?

Arguments OFF or 0 hides S-SCH in the time-slot table.

ON or 1 shows S-SCH in the time-slot table.

Measurement Modes DEMDLR6_3G

Examples :DISPlay:DLR6_3GPP:AVIew:RESult:SSCH ON
shows S-SCH in the time-slot table.

:DISPlay:DLR6_3GPP:AVIew:SRATe(?)

Sets or queries the symbol rate for the measurement in the 3GPP-R6 downlink modulation analysis.

Syntax :DISPlay:DLR6_3GPP:AVIew:SRATe { COMPOSITE | R960S
 | R480S | R240S | R120S | R60S | R30S | R15S | R7P5S }

 :DISPlay:DLR6_3GPP:AVIew:SRATe?

Arguments The arguments specify the symbol rates as listed below:

Table 3-9: Symbol rate settings, downlink

Argument	Symbol rate
COMPOSITE (default)	Corresponds to multi-rate
R960S	960k
R480S	480k
R240S	240k
R120S	120k
R60S	60k
R30S	30k
R15S	15k
R7P5S	7.5k

NOTE. If a normal analysis does not result, select **OFF** in the [:SENSe]:DLR6_3GPP:COMPOSITE command and then select one of the symbol rates (other than COMPOSITE) listed in Table 3-9.

Measurement Modes DEMDLR6_3G

Examples :DISPlay:DLR6_3GPP:AVIew:SRATe R960S
 sets the symbol rate to 960 k.

Related Commands [:SENSe]:DLR6_3GPP:COMPOSITE

:DISPlay:DLR6_3GPP:AVIew:SSCHpart(?)

Determines whether to show SCH at the head of data in the 3GPP-R6 modulation analysis.

Syntax :DISPlay:DLR6_3GPP:AVIew:SSCHpart { OFF | ON | 0 | 1 }
:DISPlay:DLR6_3GPP:AVIew:SSCHpart?

Arguments OFF or 0 hides SCH.
ON or 1 shows SCH.

Measurement Modes DEMDLR6_3G

Examples :DISPlay:DLR6_3GPP:AVIew:SSCHpart ON
shows SCH.

:DISPlay:DLR6_3GPP:AVIew:TSLot(?)

Sets or queries the number of the time slot to be displayed in the 3GPP-R6 modulation analysis.

Syntax :DISPlay:DLR6_3GPP:AVIew:TSLot <number>
:DISPlay:DLR6_3GPP:AVIew:TSLot?

Arguments <number>: :=<NR1> specifies the number of the time slot to be displayed.
Range: Slot -15999 to 0.

Measurement Modes DEMDLR6_3G

Examples :DISPlay:DLR6_3GPP:AVIew:TSLot -100
sets the time slot number to -100.

:DISPlay:DLR6_3GPP:MView|:SVIew:COLor[:SCALE]:OFFSet(?)

Sets or queries the minimum value on the color, or amplitude, axis when the view displays a spectrogram in the 3GPP-R6 modulation analysis.

Syntax :DISPlay:DLR6_3GPP:MView|:SVIew:COLor[:SCALE]:OFFSet
<value>

:DISPlay:DLR6_3GPP:MView|:SVIew:COLor[:SCALE]:OFFSet?

Arguments <value>: :=<NRf> specifies the minimum value on the color axis.
Range: -100 to 0 dBm.

Measurement Modes DEMDLR6_3G

Examples :DISPlay:DLR6_3GPP:MView:COLor:SCALE:OFFSet -100
sets the minimum value on the color axis in the main view to -100 dBm.

Related Commands :DISPlay:DLR6_3GPP:MView|:SVIew:FORMat

:DISPlay:DLR6_3GPP:MView|:SVIew:COLor[:SCALE]:RANGe(?)

Sets or queries full scale of the color, or amplitude, axis when the view displays a spectrogram in the 3GPP-R6 modulation analysis.

Syntax :DISPlay:DLR6_3GPP:MView|:SVIew:COLor[:SCALE]:RANGe
<value>

:DISPlay:DLR6_3GPP:MView|:SVIew:COLor[:SCALE]:RANGe?

Arguments <value>: :={ 5 | 10 | 20 | 50 } (dB) specifies full scale of the color axis in the spectrogram view.

Measurement Modes DEMDLR6_3G

Examples :DISPlay:DLR6_3GPP:MView:COLor:SCALE:RANGe 50
sets full scale of the color axis to 50 dB.

Related Commands :DISPlay:DLR6_3GPP:MView|:SVIew:FORMat

:DISPlay:DLR6_3GPP:MView|:SVIew:ELENgth(?)

Selects or queries the eye length of the eye diagram in the main view or subview during the 3GPP-R6 modulation analysis. This command is valid when :DISPlay:DLR6_3GPP:MView|:SVIew:FORMat is set to SIEYe, SQEYe, or STEYe.

Syntax :DISPlay:DLR6_3GPP:MView|:SVIew:ELENgth <value>

:DISPlay:DLR6_3GPP:MView|:SVIew:ELENgth?

Arguments <value>: :=<NR1> specifies the eye length of the eye diagram.
Range: 1 to 16.

Measurement Modes DEMDLR6_3G

Examples :DISPlay:DLR6_3GPP:MView:ELENgth 8
sets the eye length to 8 in the main view.

Related Commands :DISPlay:DLR6_3GPP:MView|:SVIew:FORMat

:DISPlay:DLR6_3GPP:MView|:SVIew:FORMat(?)

Selects or queries the main view or subview display format in the 3GPP-R6 modulation analysis.

Syntax :DISPlay:DLR6_3GPP:MView|:SVIew:FORMat { OFF | CSGRam
| CPCCode | CPSHortcode | CPSYmbol | CPTSlot
| SCONste | SVEctor | SEVM | SMERror | SPERror
| SIEYe | SQEYe | STEYe | STABle | CONSte | VECTor
| MAVTslot }

:DISPlay:DLR6_3GPP:MView|:SVIew:FORMat?

Arguments Table 3-10 shows the arguments and display formats:

Table 3-10: Downlink display formats

Argument	Format
OFF	Hides all measurement results
CSGRam	Code domain power spectrogram
CPCCode	Code domain power versus channelization code
CPSHortcode	Code domain power versus short code
CPSYmbol	Code domain power versus symbol
CPTSlot	Code domain power versus time slot
SCONste	Symbol constellation
SVEctor	Symbol vector
SEVM	Symbol EVM
SMERror	Symbol amplitude error
SPERror	Symbol phase error
SIEYe	Symbol eye diagram (vertical axis: I)
SQEYe	Symbol eye diagram (vertical axis: Q)
STEYe	Symbol trellis diagram (vertical axis: Phase)
STABle	Symbol table
CONSte	Constellation and modulation accuracy measurement results
VECTor	Vector locus
MAVTslot	Modulation accuracy versus Time slot

Measurement Modes DEMDLR6_3G

Examples :DISPlay:DLR6_3GPP:MView:FORMat CSGRam
displays the code domain power spectrogram in the main view.

:DISPlay:DLR6_3GPP:MView|:SVIew:POWer:SElect(?)

Selects or queries the channel to show the power for each time slot in the Code power versus Time slot view. This command is valid when :DISPlay:DLR6_3GPP:MView|:SVIew:FORMat is set to CPTSlot (Code power versus Time slot).

Syntax :DISPlay:DLR6_3GPP:MView|:SVIew:POWer:SElect
{ CODE | PSCH | SSCH }

:DISPlay:DLR6_3GPP:MView|:SVIew:POWer:SElect?

Arguments CODE shows the power of all channels or the specified channel, depending on the setting of the :DISPlay:DLR6_3GPP:MView|:SVIew:POWer[:TOTal] command.

PSCH shows the power of the P-SCH (Primary Synchronization Channel).

SSCH shows the power of the S-SCH (Secondary Synchronization Channel).

Measurement Modes DEMDLR6_3G

Examples :DISPlay:DLR6_3GPP:MView:POWer:SElect SSCH
shows the power of the S-SCH in the main view.

Related Commands :DISPlay:DLR6_3GPP:MView|:SVIew:FORMat,
:DISPlay:DLR6_3GPP:MView|:SVIew:POWer[:TOTal]

:DISPlay:DLR6_3GPP:MVIew|:SVIew:POWer[:TOTa1](?)

Determines whether to display the total power for each time slot in the Code power versus Time slot view. This command is valid when :DISPlay :DLR6_3G-PP :MVIew|:SVIew:FORMat is set to CPTSlot (Code power versus Time slot).

Syntax :DISPlay:DLR6_3GPP:MVIew|:SVIew:POWer[:TOTa1]
{ ON | OFF | 1 | 0 }

:DISPlay:DLR6_3GPP:MVIew|:SVIew:POWer[:TOTa1]?

Arguments OFF or 0 displays power of the channel specified with the :DISPlay:DLR6_3GPP:AVIew:CNUMber command.

ON or 1 displays the total power of all channels for each time slot.

Measurement Modes DEMDLR6_3G

Examples :DISPlay:DLR6_3GPP:MVIew:POWer:TOTa1 ON
displays the total power of all channels for each time slot in the main view.

Related Commands :DISPlay:DLR6_3GPP:MVIew|:SVIew:FORMat

:DISPlay:DLR6_3GPP:MVIew|:SVIew:RADix(?)

Selects or queries the base of symbols on the main view or subview in the 3GPP-R6 modulation analysis.

This command is valid when :DISPlay:DLR6_3GPP:MVIew|:SVIew:FORMat is set to STABle (symbol table).

Syntax :DISPlay:DLR6_3GPP:MVIew|:SVIew:RADix
{ BINary | OCTal | HEXadecimal }
:DISPlay:DLR6_3GPP:MVIew|:SVIew:RADix?

Arguments BINary selects binary notation.

OCTal selects octal notation.

HEXadecimal selects hexadecimal notation.

Measurement Modes DEMDLR6_3G

Examples :DISPlay:DLR6_3GPP:MVIew:RADix BINary
selects binary notation for the base of symbols in the main view.

Related Commands :DISPlay:DLR6_3GPP:MVIew|:SVIew:FORMat

:DISPlay:DLR6_3GPP:MVlew|:SVlew:X[:SCALe]:OFFSet(?)

Sets or queries the minimum horizontal value (left end) on the main view or subview in the 3GPP-R6 modulation analysis.

Syntax :DISPlay:DLR6_3GPP:MVlew|:SVlew:X[:SCALe]:OFFSet
<value>

:DISPlay:DLR6_3GPP:MVlew|:SVlew:X[:SCALe]:OFFSet?

Arguments <value>: :=<NRf> specifies the minimum horizontal value in the main view. The valid range depends on the display format. Refer to Table A-1 in Appendix A.

Measurement Modes DEMDLR6_3G

Examples :DISPlay:DLR6_3GPP:MVlew:X:SCALe:OFFSet 0
sets the minimum horizontal value to channel 0 when the main view displays a code domain power spectrogram.

Related Commands :DISPlay:DLR6_3GPP:MVlew|:SVlew:FORMat

:DISPlay:DLR6_3GPP:MVlew|:SVlew:X[:SCALe]:RANGe(?)

Sets or queries full scale of the horizontal axis on the main view or subview in the 3GPP-R6 modulation analysis.

Syntax :DISPlay:DLR6_3GPP:MVlew|:SVlew:X[:SCALe]:RANGe
<value>

:DISPlay:DLR6_3GPP:MVlew|:SVlew:X[:SCALe]:RANGe?

Arguments <value>: :=<NRf> specifies full scale of the horizontal axis in the main view. The valid range depends on the display format. Refer to Table A-1 in Appendix A.

Measurement Modes DEMDLR6_3G

Examples :DISPlay:DLR6_3GPP:MVlew:X:SCALe:RANGe 512
sets the horizontal full scale to 512 channels when the main view displays a code domain power spectrogram.

Related Commands :DISPlay:DLR6_3GPP:MVlew|:SVlew:FORMat

:DISPlay:DLR6_3GPP:MView|:SVIew:Y[:SCALe]:FIT (No Query Form)

Runs auto-scale on the main view or subview in the 3GPP-R6 modulation analysis. The auto-scale automatically sets the start value and scale of the vertical axis to best display the waveform.

This command is valid when :DISPlay:DLR6_3GPP:MView|:SVIew:FORMat is set to CPHortcode, CPSYmbol, CPTSlot, SEVM, SMERror, or SPERror.

Syntax :DISPlay:DLR6_3GPP:MView|:SVIew:Y[:SCALe]:FIT

Arguments None

Measurement Modes DEMDLR6_3G

Examples :DISPlay:DLR6_3GPP:MView:Y:SCALe:FIT
runs the auto-scale on the main view.

Related Commands :DISPlay:DLR6_3GPP:MView|:SVIew:FORMat

:DISPlay:DLR6_3GPP:MView|:SVIew:Y[:SCALe]:FULL (No Query Form)

Sets the main view or subview's vertical axis to the default full scale in the 3GPP-R6 modulation analysis.

This command is valid when :DISPlay:DLR6_3GPP:MView|:SVIew:FORMat is set to CPHortcode, CPSYmbol, CPTSlot, SEVM, SMERror, or SPERror.

Syntax :DISPlay:DLR6_3GPP:MView|:SVIew:Y[:SCALe]:FULL

Arguments None

Measurement Modes DEMDLR6_3G

Examples :DISPlay:DLR6_3GPP:MView:Y:SCALe:FULL
sets the main view's vertical axis to the default full scale.

Related Commands :DISPlay:DLR6_3GPP:MView|:SVIew:FORMat

:DISPlay:DLR6_3GPP:MVIew|:SVIew:Y[:SCALe]:OFFSet(?)

Sets or queries the minimum vertical value (bottom end) in the main view or subview in the 3GPP-R6 modulation analysis.

This command is valid when :DISPlay:DLR6_3GPP:MVIew|:SVIew:FORMat is set to CPSHortcode, CPSYmbol, CPTSlot, SEVM, SMERror, or SPERror.

Syntax :DISPlay:DLR6_3GPP:MVIew|:SVIew:Y[:SCALe]:OFFSet
<value>

:DISPlay:DLR6_3GPP:MVIew|:SVIew:Y[:SCALe]:OFFSet?

Arguments <value>: :=<NRf> specifies the minimum vertical value in the main view. The valid range depends on the display format. Refer to Table A-1 in Appendix A.

Measurement Modes DEMDLR6_3G

Examples :DISPlay:DLR6_3GPP:MVIew:Y:SCALe:OFFSet 0
sets the bottom end of the vertical axis to channel 0 when the main view displays a code domain power spectrogram.

Related Commands :DISPlay:DLR6_3GPP:MVIew|:SVIew:FORMat

:DISPlay:DLR6_3GPP:MView|:SVIew:Y[:SCALe]:PUNit(?)

Selects or queries the unit on the Y (power) axis in the main view or subview during the 3GPP-R6 modulation analysis.

This command is valid when :DISPlay:DLR6_3GPP:MView|:SVIew:FORMat is set to CSGRam, CPSHortcode, CPSYmbol, or CPTSlot.

Syntax :DISPlay:DLR6_3GPP:MView|:SVIew:Y[:SCALe]:PUNit
{ RELative | ABSolute }

:DISPlay:DLR6_3GPP:MView|:SVIew:Y[:SCALe]:PUNit?

Arguments RELative represents the relative channel power to the total power of all the channels along the Y axis in dB.

ABSolute represents the absolute power of each channel along the Y axis in dBm.

Measurement Modes DEMDLR6_3G

Examples :DISPlay:DLR6_3GPP:MView:Y:SCALe:PUNit RELative
represents the relative power along the Y axis in the main view.

Related Commands :DISPlay:DLR6_3GPP:MView|:SVIew:FORMat

:DISPlay:DLR6_3GPP:MView|:SView:Y[:SCALE]:RANGe(?)

Sets or queries full scale of the vertical axis on the main view or subview in the 3GPP-R6 modulation analysis.

This command is valid when :DISPlay:DLR6_3GPP:MView|:SView:FORMat is set to CSGRam, CPHortcode, CPSYmbol, CPTSlot, SEVM, SMERror, or SPERror.

Syntax :DISPlay:DLR6_3GPP:MView|:SView:Y[:SCALE]:RANGe
<value>

:DISPlay:DLR6_3GPP:MView|:SView:Y[:SCALE]:RANGe?

Arguments <value> : :=<NRf> specifies full scale of the vertical axis in the main view. The valid range depends on the display format. Refer to Table A-1 in Appendix A.

Measurement Modes DEMDLR6_3G

Examples :DISPlay:DLR6_3GPP:MView:Y:SCALE:RANGe 50
sets the vertical full scale to 50 slots when the main view displays a power codogram.

Related Commands :DISPlay:DLR6_3GPP:MView|:SView:FORMat

:DISPlay:ULR6_3GPP Subgroup

The :DISPlay:ULR6_3GPP commands control display of the 3GPP-R6 uplink modulation analysis.

NOTE. To use a command from this group, you must have selected DEMULR6_3G (3GPP-R6 uplink modulation analysis) in the :INSTRument[:SElect] command.

Command Tree	Header	Parameter
	:DISPlay	
	:ULR6_3GPP	
	:AVIew	
	:CCODE	<number>
	:CNUMBER	<number>
	:FORMat	CHANnel IQSPlit
	:IQBRanch	I Q BOTH
	:RESult	
	:ANACK	<boolean>
	:CQI	<boolean>
	:ETFCi	<boolean>
	:HAPPY	<boolean>
	:PREamble	<boolean>
	:RSN	<boolean>
	:TFCI	<boolean>
	:TPC	<boolean>
	:SRATE	COMPOSITE R1920S R960S R480S R240S R120S R60S R30S R15S
	:TSLot	<number>
	:MVIew :SVIew	
	:COLor	
	[:SCALE]	
	:OFFSet	<amplitude>
	:RANge	<relative_amplitude>
	:ELENgth	<numeric_value>
	:FORMat	OFF CSGRam CPCNumber CPSYmbol CPTSlot SCONste SVECTOR SEVM SMERror SPERror SIEYe SQEYe STEYe STABle CONSte VECTor MAVTslot GRATio
	:IQComposite	<boolean>
	:NUMBER	SINGLE SPLit
	:POWER	
	[:TOTal]	<boolean>
	:PREference	TOTal DPCCCh

```
:RADix      BINary | OCTal | HEXadecimal
:ROtation   <numeric_value>
:X
  [:SCALE]
    :LINE    <numeric_value>
    :OFFSet  <numeric_value>
    :RANGe   <numeric_value>
:Y
  [:SCALE]
    :FIT
    :FULL
    :OFFSet  <numeric_value>
    :PUNit   RELative | ABSolute
    :RANGe   <numeric_value>
```

:DISPlay:ULR6_3GPP:AVIew:CCODE(?)

Sets or queries the channelization code to position the marker in the 3GPP-R6 uplink analysis. This command is valid when :DISPlay:ULR6_3GPP:AVIew:FORMat is set to IQSPlit.

Syntax :DISPlay:ULR6_3GPP:AVIew:CCODE <number>
:DISPlay:ULR6_3GPP:AVIew:CCODE?

Arguments <number> ::= <NR1> specifies the channelization code.
Range: Channel 0 to 255.

Measurement Modes DEMULR6_3G

Examples :DISPlay:ULR6_3GPP:AVIew:CCODE 100
sets the channelization code to 100 to position the marker.

Related Commands :DISPlay:ULR6_3GPP:AVIew:FORMat

:DISPlay:ULR6_3GPP:AVIew:CNUMBER(?)

Sets or queries the channel number to position the marker in the 3GPP-R6 uplink analysis. This command is valid when :DISPlay:ULR6_3GPP:AVIew:FORMat is set to CHANnel.

Syntax :DISPlay:ULR6_3GPP:AVIew:CNUMBER <number>
:DISPlay:ULR6_3GPP:AVIew:CNUMBER?

Arguments <number> ::= <NR1> specifies the channel number.
Range: Channel 0 to 12.

Measurement Modes DEMULR6_3G

Examples :DISPlay:ULR6_3GPP:AVIew:CNUMBER 5
sets the channel number to 5 to position the marker.

Related Commands :DISPlay:ULR6_3GPP:AVIew:FORMat

:DISPlay:ULR6_3GPP:AVIew:FORMat(?)

Selects or queries the view format in the 3GPP-R6 uplink analysis.

Syntax :DISPlay:ULR6_3GPP:AVIew:FORMat { CHANnel | IQSPlit }
:DISPlay:ULR6_3GPP:AVIew:FORMat?

Arguments CHANnel displays the measurement result for the channels.
IQSPlit displays the measurement result for the I and/or Q branch. Use the :DISPlay:ULR6_3GPP:AVIew:IQBRanch command to select the I/Q branch.

Measurement Modes DEMULR6_3G

Examples :DISPlay:ULR6_3GPP:AVIew:FORMat BOTH
displays the measurement result for both I and Q branches.

Related Commands :DISPlay:ULR6_3GPP:AVIew:IQBRanch

:DISPlay:ULR6_3GPP:AVIew:IQBRanch(?)

Selects or queries the I/Q branch when :DISPlay:ULR6_3GPP:AVIew:FORMat is set to IQSPlit in the 3GPP-R6 uplink analysis.

Syntax :DISPlay:ULR6_3GPP:AVIew:IQBRanch { I | Q | BOTH }
:DISPlay:ULR6_3GPP:AVIew:IQBRanch?

Arguments I displays the measurement result for the I branch.
Q displays the measurement result for the Q branch.
BOTH displays the measurement result for both branches.

Measurement Modes DEMULR6_3G

Examples :DISPlay:ULR6_3GPP:AVIew:IQBRanch BOTH
displays the measurement result for both I and Q branches.

Related Commands :DISPlay:ULR6_3GPP:AVIew:FORMat

:DISPlay:ULR6_3GPP:AVIew:RESult:ANACK(?)

Determines whether to show or hide ACK/NACK in the time-slot table.

Syntax :DISPlay:ULR6_3GPP:AVIew:RESult:ANACK
{ OFF | ON | 0 | 1 }

:DISPlay:ULR6_3GPP:AVIew:RESult:ANACK?

Arguments OFF or 0 hides ACK/NACK in the time-slot table.

ON or 1 shows ACK/NACK in the time-slot table.

Measurement Modes DEMULR6_3G

Examples :DISPlay:ULR6_3GPP:AVIew:RESult:ANACK ON
shows ACK/NACK in the time-slot table.

:DISPlay:ULR6_3GPP:AVIew:RESult:CQI(?)

Determines whether to show or hide CQI (Channel Quality Indicator) value in the time-slot table.

Syntax :DISPlay:ULR6_3GPP:AVIew:RESult:CQI { OFF | ON | 0 | 1 }

:DISPlay:ULR6_3GPP:AVIew:RESult:CQI?

Arguments OFF or 0 hides CQI value in the time-slot table.

ON or 1 shows CQI value in the time-slot table.

Measurement Modes DEMULR6_3G

Examples :DISPlay:ULR6_3GPP:AVIew:RESult:CQI ON
shows CQI value in the time-slot table.

:DISPlay:ULR6_3GPP:AVIew:RESult:ETFCi(?)

Determines whether to show or hide E-TFCI (Enhanced TFCI) value in the time-slot table.

Syntax :DISPlay:ULR6_3GPP:AVIew:RESult:ETFCi
{ OFF | ON | 0 | 1 }

:DISPlay:ULR6_3GPP:AVIew:RESult:ETFCi?

Arguments OFF or 0 hides E-TFCI value in the time-slot table.

ON or 1 shows E-TFCI value in the time-slot table.

Measurement Modes DEMULR6_3G

Examples :DISPlay:ULR6_3GPP:AVIew:RESult:ETFCi ON
shows E-TFCI value in the time-slot table.

:DISPlay:ULR6_3GPP:AVIew:RESult:HAPPy(?)

Determines whether to show or hide Happy bit value in the time-slot table.

Syntax :DISPlay:ULR6_3GPP:AVIew:RESult:HAPPy
{ OFF | ON | 0 | 1 }

:DISPlay:ULR6_3GPP:AVIew:RESult:HAPPy?

Arguments OFF or 0 hides Happy bit value in the time-slot table.

ON or 1 shows Happy bit value in the time-slot table.

Measurement Modes DEMULR6_3G

Examples :DISPlay:ULR6_3GPP:AVIew:RESult:HAPPy ON
shows Happy bit value in the time-slot table.

:DISPlay:ULR6_3GPP:AVIew:RESult:OFFSet(?)

Determines whether to show or hide Subframe to Time-slot Offset (STO) in the time-slot table.

Syntax :DISPlay:ULR6_3GPP:AVIew:RESult:OFFSet
{ OFF | ON | 0 | 1 }

:DISPlay:ULR6_3GPP:AVIew:RESult:OFFSet?

Arguments OFF or 0 hides STO in the time-slot table.

ON or 1 shows STO in the time-slot table.

Measurement Modes DEMULR6_3G

Examples :DISPlay:ULR6_3GPP:AVIew:RESult:OFFSet ON
shows STO in the time-slot table.

:DISPlay:ULR6_3GPP:AVIew:RESult:PREamble(?)

Determines whether to show or hide Preamble in the time-slot table.

Syntax :DISPlay:ULR6_3GPP:AVIew:RESult:PREamble
{ OFF | ON | 0 | 1 }

:DISPlay:ULR6_3GPP:AVIew:RESult:PREamble?

Arguments OFF or 0 hides Preamble in the time-slot table.

ON or 1 shows Preamble in the time-slot table.

Measurement Modes DEMULR6_3G

Examples :DISPlay:ULR6_3GPP:AVIew:RESult:PREamble ON
shows Preamble in the time-slot table.

:DISPlay:ULR6_3GPP:AVIew:RESult:RSN(?)

Determines whether to show or hide RSN (Retransmission Sequence Number) in the time-slot table.

Syntax :DISPlay:ULR6_3GPP:AVIew:RESult:RSN { OFF | ON | 0 | 1 }
:DISPlay:ULR6_3GPP:AVIew:RESult:RSN?

Arguments OFF or 0 hides RSN in the time-slot table.
ON or 1 shows RSN in the time-slot table.

Measurement Modes DEMULR6_3G

Examples :DISPlay:ULR6_3GPP:AVIew:RESult:RSN ON
shows RSN in the time-slot table.

:DISPlay:ULR6_3GPP:AVIew:RESult:SIGNature(?)

Determines whether to show or hide Signature Number in the time-slot table.

Syntax :DISPlay:ULR6_3GPP:AVIew:RESult:SIGNature
{ OFF | ON | 0 | 1 }
:DISPlay:ULR6_3GPP:AVIew:RESult:SIGNature?

Arguments OFF or 0 hides Signature Number in the time-slot table.
ON or 1 shows Signature Number in the time-slot table.

Measurement Modes DEMULR6_3G

Examples :DISPlay:ULR6_3GPP:AVIew:RESultSIGNature ON
shows Signature Number in the time-slot table.

:DISPlay:ULR6_3GPP:AVIew:RESult:TPC(?)

Determines whether to show or hide TPC (Transmit Power Control) value in the time-slot table.

Syntax :DISPlay:ULR6_3GPP:AVIew:RESult:TPC { OFF | ON | 0 | 1 }
:DISPlay:ULR6_3GPP:AVIew:RESult:TPC?

Arguments OFF or 0 hides TPC in the time-slot table.
ON or 1 shows TPC in the time-slot table.

Measurement Modes DEMULR6_3G

Examples :DISPlay:ULR6_3GPP:AVIew:RESultTPC ON
shows TPC in the time-slot table.

:DISPlay:ULR6_3GPP:AVIew:RESult:SIGNature(?)

Determines whether to show or hide Signature Number in the time-slot table.

Syntax :DISPlay:ULR6_3GPP:AVIew:RESult:SIGNature
{ OFF | ON | 0 | 1 }
:DISPlay:ULR6_3GPP:AVIew:RESult:SIGNature?

Arguments OFF or 0 hides Signature Number in the time-slot table.
ON or 1 shows Signature Number in the time-slot table.

Measurement Modes DEMULR6_3G

Examples :DISPlay:ULR6_3GPP:AVIew:RESultSIGNature ON
shows Signature Number in the time-slot table.

:DISPlay:ULR6_3GPP:AVIew:SRATe(?)

Sets or queries the symbol rate for the measurement in the 3GPP-R6 uplink modulation analysis.

Syntax :DISPlay:ULR6_3GPP:AVIew:SRATe { COMPOSITE | R1920S
| R960S | R480S | R240S | R120S | R60S | R30S | R15S }

:DISPlay:ULR6_3GPP:AVIew:SRATe?

Arguments The arguments specify the symbol rates as listed below:

Table 3-11: Symbol rate settings, uplink

Argument	Symbol rate
COMPOSITE (default)	Corresponds to multi-rate
R1920S	1920 k
R960S	960 k
R480S	480 k
R240S	240 k
R120S	120 k
R60S	60 k
R30S	30 k
R15S	15 k

Measurement Modes DEMULR6_3G

Examples :DISPlay:ULR6_3GPP:AVIew:SRATe R960S
sets the symbol rate to 960 k.

:DISPlay:ULR6_3GPP:AVIew:TSLot(?)

Sets or queries the number of the time slot to be displayed in the 3GPP-R6 modulation analysis.

Syntax :DISPlay:ULR6_3GPP:AVIew:TSLot <number>

:DISPlay:ULR6_3GPP:AVIew:TSLot?

Arguments <number> ::= <NR1> specifies the number of the time slot to be displayed.
Range: Slot -15999 to 0.

Measurement Modes DEMULR6_3G

Examples :DISPlay:ULR6_3GPP:AVIew:TSLot -100
sets the time slot number to -100.

:DISPlay:ULR6_3GPP:MView|:SVIew:COLor[:SCALE]:OFFSet(?)

Sets or queries the minimum value of the color, or amplitude, axis when the subview displays a spectrogram in the 3GPP-R6 modulation analysis.

Syntax :DISPlay:ULR6_3GPP:MVIEw|:SVIEw:COLor[:SCALE]:OFFSet
<value>

:DISPlay:ULR6_3GPP:MVIEw|:SVIEw:COLor[:SCALE]:OFFSet?

Arguments <value>: :=<NRf> specifies the minimum color-axis value.
Range: -100 to 0 dBm.

Measurement Modes DEMULR6_3G

Examples :DISPlay:DLR6_3GPP:SVIEw:COLor:SCALE:OFFSet -100
sets the minimum color-axis value in the subview to -100 dBm.

Related Commands :DISPlay:ULR6_3GPP:MVIEw|:SVIEw:FORMat

:DISPlay:ULR6_3GPP:MView|:SVIew:COLor[:SCALE]:RANGe(?)

Sets or queries full scale of the color, or amplitude, axis when the subview displays a spectrogram in the 3GPP-R6 modulation analysis.

Syntax :DISPlay:ULR6_3GPP:MVIEw|:SVIEw:COLor[:SCALE]:RANGe
<value>

:DISPlay:ULR6_3GPP:MVIEw|:SVIEw:COLor[:SCALE]:RANGe?

Arguments <value>: :={ 5 | 10 | 20 | 50 } (dB) specifies full scale of the color axis.

Measurement Modes DEMULR6_3G

Examples :DISPlay:DLR6_3GPP:SVIEw:COLor:SCALE:RANGe 50
sets full scale of the color axis to 50 dB in the subview.

Related Commands :DISPlay:ULR6_3GPP:MVIEw|:SVIEw:FORMat

:DISPlay:ULR6_3GPP:MView|:SVIew:ELENgth(?)

Selects or queries the eye length of the eye diagram in the main view or subview during the 3GPP-R6 modulation analysis. This command is valid when :DISPlay:ULR6_3GPP:MView|:SVIew:FORMat is set to SIEYe, SQEYe, or STEYe.

Syntax :DISPlay:ULR6_3GPP:MView|:SVIew:ELENgth <value>

:DISPlay:ULR6_3GPP:MView|:SVIew:ELENgth?

Arguments <value>: :=<NR1> specifies the eye length of the eye diagram.
Range: 1 to 16.

Measurement Modes DEMULR6_3G

Examples :DISPlay:ULR6_3GPP:MView:ELENgth 8
sets the eye length to 8 in the main view.

Related Commands :DISPlay:ULR6_3GPP:MView|:SVIew:FORMat

:DISPlay:ULR6_3GPP:MView|:SVIew:FORMat(?)

Sets or queries the main view or subview display format in the 3GPP-R6 modulation analysis.

Syntax :DISPlay:ULR6_3GPP:MView|:SVIew:FORMat { OFF | CSGRam | CPCNumber | CPSYmbol | CPTSlot | SCONste | SVEctor | SEVM | SMERror | SPERror | SIEYe | SQEYe | STEYe | STABle | CONSte | VECTor | MAVTslot | GRATio }

:DISPlay:ULR6_3GPP:MView|:SVIew:FORMat?

Arguments Table 3-12 shows the arguments and display formats:

Table 3-12: Uplink display formats

Argument	Format
OFF	Hides all measurement results
SPECTrum	Spectrum
CPSHortcode	Code domain power versus short code
CSGRam	Code domain power spectrogram
CPTSlot	Code domain power versus time slot
CPSYmbol	Code domain power versus symbol
SCONste	Symbol constellation
SEVM	Symbol EVM
SVEctor	Symbol vector
SMERror	Symbol amplitude error
SPERror	Symbol phase error
SIEYe	Symbol eye diagram (vertical axis: I)
SQEYe	Symbol eye diagram (vertical axis: Q)
STEYe	Symbol trellis diagram (vertical axis: Phase)
STABle	Symbol table
CONSte	Constellation and modulation accuracy measurement results
VECTor	Vector locus
MAVTslot	Modulation accuracy versus Time slot
GRATio	Gain ratio

Measurement Modes DEMULR6_3G

Examples :DISPlay:DLR6_3GPP:SVIew:FORMat CSGRam
displays the code domain power spectrogram in the subview.

:DISPlay:ULR6_3GPP:MView|:SVIew:NUMBER(?)

Selects or queries the number of graphs displayed on the main view or subview in the 3GPP-R6 uplink analysis.

Syntax :DISPlay:ULR6_3GPP:MView|:SVIew:NUMBER
{ SINGle | SPLit }

:DISPlay:ULR6_3GPP:MView|:SVIew:NUMBER?

Arguments SINGle displays one graph on the view.

SPLit displays two graphs on the view.

Measurement Modes DEMULR6_3G

Examples :DISPlay:DLR6_3GPP:ULR6_3GPP:MView:NUMBER SPLit
displays two graphs on the main view.

:DISPlay:ULR6_3GPP:MView|:SVIew:POWer[:TOTal](?)

Determines whether to display the total power for each time slot in the Code power versus Time slot view. This command is valid when :DISPlay:ULR6_3GPP:MView|:SVIew:FORMat is set to CPTSlot (Code power versus Time slot).

Syntax ::DISPlay:ULR6_3GPP:MView|:SVIew:POWer[:TOTal]
{ ON | OFF | 1 | 0 }

:DISPlay:ULR6_3GPP:MView|:SVIew:POWer[:TOTal]?

Arguments OFF or 0 displays power of the channel specified with the :DISPlay:ULR6_3GPP:AVIew:CNUMBER command.

ON or 1 displays the total power of all channels for each time slot.

Measurement Modes DEMULR6_3G

Examples :DISPlay:ULR6_3GPP:MView:POWer:TOTal ON
displays the total power of all channels for each time slot in the main view.

Related Commands :DISPlay:ULR6_3GPP:MView|:SVIew:FORMat

:DISPlay:ULR6_3GPP:MView|:SVIew:PREFERENCE(?)

Selects or queries the power reference in the main view or subview in the 3GPP-R6 uplink analysis.

This command is valid when :DISPlay:ULR6_3GPP MView|:SVIew:FORMat is set to CSGRam, CPCNumber, or CPSYmbol.

Syntax :DISPlay:ULR6_3GPP:MView|:SVIew:PREFERENCE
{ TOTa1 | DPCCh }

:DISPlay:ULR6_3GPP:MView|:SVIew::PREFERENCE?

Arguments TOTa1 selects the total power as the power reference.

DPCCh selects the DPCCH power as the power reference.

Measurement Modes DEMULR6_3G

Examples :DISPlay:DLR6_3GPP:ULR6_3GPP:MView:PREFERENCE TOTa1
selects the total power as the power reference.

Related Commands :DISPlay:ULR6_3GPP:MView|:SVIew:FORMat

:DISPlay:ULR6_3GPP:MView|:SVIew:RADix(?)

Selects or queries the base of symbols on the main view or subview in the 3GPP-R6 modulation analysis.

NOTE. This command is valid when
:DISPlay:ULR6_3GPP:MView|:SVIew:FORMat is set to STABLE (symbol table).

Syntax :DISPlay:ULR6_3GPP:MView|:SVIew:RADix
{ BINary | OCTal | HEXadecimal }

:DISPlay:ULR6_3GPP:MView|:SVIew:RADix?

Arguments BINary selects binary notation.

OCTal selects octal notation.

HEXadecimal selects hexadecimal notation.

Measurement Modes DEMULR6_3G

Examples :DISPlay:ULR6_3GPP:MView:RADix BINary
selects binary notation for the base of symbols in the main view.

Related Commands :DISPlay:ULR6_3GPP:MView|:SVIew:FORMat

:DISPlay:ULR6_3GPP:MView|:SVIew:ROTation(?)

Selects or queries the rotation of the symbol table in the main view or subview during the 3GPP-R6 modulation analysis. This command is valid when :DISPlay :ULR6_3GPP:MView|:SVIew:FORMat is set to STABLE (symbol table).

Syntax :DISPlay:ULR6_3GPP:MView|:SVIew:ROTation <value>
:DISPlay:ULR6_3GPP:MView|:SVIew:ROTation?

Arguments <value> : :=<NR1> specifies the rotation of the symbol table.
Range: 0 to 3.

Measurement Modes DEMULR6_3G

Examples :DISPlay:ULR6_3GPP:MView:ROTation 1
sets the rotation to 1 in the main view.

Related Commands :DISPlay:ULR6_3GPP:MView|:SVIew:FORMat

:DISPlay:ULR6_3GPP:MView|:SVIew:X[:SCALe]:LINE(?)

Sets or queries the position of the horizontal line when the main view or subview displays the gain ratio measurement. This command is valid when :DISPlay :ULR6_3GPP:MView|:SVIew:FORMat is set to GRATIo.

Syntax :DISPlay:ULR6_3GPP:MView|:SVIew:X[:SCALe]:LINE <value>
:DISPlay:ULR6_3GPP:MView|:SVIew:X[:SCALe]:LINE?

Arguments <value> : :=<NRf> specifies the position of the horizontal line.
Range: -100 to 30 dBm.

Measurement Modes DEMULR6_3G

Examples :DISPlay:DLR6_3GPP:SVIew:X:SCALe:LINE -10
positions the horizontal line at -10 dBm.

Related Commands :DISPlay:ULR6_3GPP:MView|:SVIew:FORMat

:DISPlay:ULR6_3GPP:MView|SVIew:X[:SCALe]:OFFSet(?)

Sets or queries the minimum horizontal value (left end) in the main view or subview in the 3GPP-R6 modulation analysis.

Syntax :DISPlay:ULR6_3GPP:MView|:SVIew:X[:SCALe]:OFFSet
<value>

:DISPlay:ULR6_3GPP:MView|:SVIew:X[:SCALe]:OFFSet?

Arguments <value>: :=<Nrf> specifies the minimum horizontal value in the subview. The valid range depends on the display format. Refer to Table A-1 in Appendix A.

Measurement Modes DEMULR6_3G

Examples :DISPlay:DLR6_3GPP:SVIew:X:SCALe:OFFSet 0
sets the minimum horizontal value to channel 0 when the subview displays a power codogram.

Related Commands :DISPlay:ULR6_3GPP:MView|:SVIew:FORMat

:DISPlay:ULR6_3GPP:MView|SVIew:X[:SCALe]:RANGe(?)

Sets or queries full scale of the horizontal axis in the main view or subview in the 3GPP-R6 modulation analysis.

Syntax :DISPlay:ULR6_3GPP:MView|:SVIew:X[:SCALe]:RANGe
<value>

:DISPlay:ULR6_3GPP:MView|:SVIew:X[:SCALe]:RANGe?

Arguments <value>: :=<Nrf> specifies full scale of the horizontal axis in the subview. The valid range depends on the display format. Refer to Table A-1 in Appendix A.

Measurement Modes DEMULR6_3G

Examples :DISPlay:DLR6_3GPP:SVIew:X:SCALe:RANGe 512
sets the horizontal full scale to 512 channels when the subview displays a code domain power spectrogram.

Related Commands :DISPlay:ULR6_3GPP:MView|:SVIew:FORMat

:DISPlay:ULR6_3GPP:MVlew|:SVlew:Y[:SCALe]:FIT (No Query Form)

Runs auto-scale in the main view or subview in the 3GPP-R6 modulation analysis. The auto-scale automatically sets the start value and scale of the vertical axis to best display the waveform.

This command is valid when :DISPlay:ULR6_3GPP:MVlew|:SVlew:FORMat is set to CPHortcode, CPSYmbol, CPTSlot, SEVM, SMERror, or SPERror.

Syntax :DISPlay:ULR6_3GPP:MVlew|:SVlew:Y[:SCALe]:FIT

Arguments None

Measurement Modes DEMULR6_3G

Examples :DISPlay:DLR6_3GPP:MVlew:Y:SCALe:FIT
runs the auto-scale on the main view.

Related Commands :DISPlay:ULR6_3GPP:MVlew|:SVlew:FORMat

:DISPlay:ULR6_3GPP:MVlew|:SVlew:Y[:SCALe]:FULL (No Query Form)

Sets the main view or subview's vertical axis to the default full-scale value in the 3GPP-R6 modulation analysis.

This command is valid when :DISPlay:ULR6_3GPP:MVlew|:SVlew:FORMat is set to CPHortcode, CPSYmbol, CPTSlot, SEVM, SMERror, or SPERror.

Syntax :DISPlay:ULR6_3GPP:MVlew|:SVlew:Y[:SCALe]:FULL

Arguments None

Measurement Modes DEMULR6_3G

Examples :DISPlay:DLR6_3GPP:MVlew:Y:SCALe:FULL
sets the main view's vertical axis to the default full-scale value.

Related Commands :DISPlay:ULR6_3GPP:MVlew|:SVlew:FORMat

:DISPlay:ULR6_3GPP:MView|:SVIew:Y[:SCALe]:OFFSet(?)

Sets or queries the minimum vertical value (bottom end) in the main view or subview in the 3GPP-R6 modulation analysis.

This command is valid when :DISPlay:ULR6_3GPP:MView|:SVIew:FORMat is set to CSGRam, CPSHortcode, CPSYmbol, CPTSlot, SEVM, SMERror, or SPERror.

Syntax :DISPlay:ULR6_3GPP:MView|:SVIew:Y[:SCALe]:OFFSet
<value>

:DISPlay:ULR6_3GPP:MView|:SVIew:Y[:SCALe]:OFFSet?

Arguments <value> ::= <Nrf> specifies the minimum vertical value in the subview. The valid range depends on the display format. Refer to Table A-1 in Appendix A.

Measurement Modes DEMULR6_3G

Examples :DISPlay:DLR6_3GPP:MView:Y:SCALe:OFFSet 0
sets the bottom of the vertical axis to channel 0 when the main view displays a code domain power spectrogram.

Related Commands :DISPlay:ULR6_3GPP:MView|:SVIew:FORMat

:DISPlay:ULR6_3GPP:MView|:SVIew:Y[:SCALe]:PUNit(?)

Selects or queries the unit on the Y (color) axis in the main view or subview during the 3GPP-R6 modulation analysis.

This command is valid when :DISPlay:ULR6_3GPP:MView|:SVIew:FORMat is set to CSGRam, CPSHortcode, CPSYmbol, or CPTSlot.

Syntax :DISPlay:ULR6_3GPP:MView|:SVIew:Y[:SCALe]:PUNit
{ RELative | ABSolute }

:DISPlay:ULR6_3GPP:MView|:SVIew:Y[:SCALe]:PUNit?

Arguments RELative represents the relative channel power to the total power of all the channels along the Y axis in dB.

ABSolute represents the absolute power of each channel along the Y axis in dBm.

Measurement Modes DEMULR6_3G

Examples :DISPlay:DLR6_3GPP:SVIew:Y:SCALe:PUNit RELative
represents the relative power along the Y axis in the subview.

Related Commands :DISPlay:ULR6_3GPP:MView|:SVIew:FORMat

:DISPlay:ULR6_3GPP:MView|:SVIew:Y[:SCALE]:RANGe(?)

Sets or queries full scale of the vertical axis in the main view or subview in the 3GPP-R6 modulation analysis.

This command is valid when :DISPlay:ULR6_3GPP:MView|:SVIew:FORMat is set to CSGRam, CPSHortcode, CPSYmbol, CPTSlot, SEVM, SMERror, or SPERror.

Syntax :DISPlay:ULR6_3GPP:MView|:SVIew:Y[:SCALE]:RANGe
<value>

Arguments <value> ::= <NRf> specifies full scale of the vertical axis in the subview. The valid range depends on the display format. Refer to Table A-1 in Appendix A.

Measurement Modes DEMULR6_3G

Examples :DISPlay:DLR6_3GPP:SVIew:Y:SCALE:RANGe 50
sets the vertical axis full scale to 50 slots when the subview displays a code domain power spectrogram.

Related Commands :DISPlay:ULR6_3GPP:MView|:SVIew:FORMat

:FETCh Commands

The :FETCh commands retrieve the measurements from the data taken by the latest :INITiate command.

NOTE. To use a :FETCh command, you must have set a measurement mode for the FETCh operation using the :INSTRument[:SElect] command (refer to the WCA230A and WCA280A Programmer Manual).

Command Tree

Header	Parameter
:FETCh	
:DLR6_3GPP?	CCODE CSYMBOL CTSLOT SCONSTE EVM AEVM PEVM MERROR AMERROR PMERROR PERROR APERROR PPEROR RHO FERROR OOFFSET STABLE TSNUMBER SSCHANNEL SCGROUP SCNUMBER TLENGTH PCDE CEVM CMERROR CPERROR CRHO COOF AGSCOPE AGVALUE RGRANT ANACK
:ULR6_3GPP?	NACK CNUMBER CSYMBOL CTSLOT SCONSTE EVM AEVM PEVM MERROR AMERROR PMERROR PERROR APERROR PPEROR RHO FERROR OOFFSET STABLE TSNUMBER SSCHANNEL SCGROUP SCNUMBER TLENGTH PCDE CEVM CMERROR CPERROR CRHO COOF PDISCONT TFCI TPC ETFCI HAPPY CINFORMATION

For the :FETCh:DLR6_3GPP and :FETCh:ULR6_3GPP command subgroups, if you want to perform a FETCh operation on fresh data, use the [:SENSE] :DLR6_3GPP[:IMMEDIATE] or the [:SENSE]:ULR6_3GPP[:IMMEDIATE] command (refer to page 3-85 or 3-98, respectively).

:FETCh:DLR6_3GPP? (Query Only)

Returns measurement results of the 3GPP-R6 downlink modulation analysis.

Syntax :FETCh:DLR6_3GPP? { CCODE | CSYMBOL | CTSLOT | SCNSTE
| EVM | AEVM | PEVM | MERROR | AMERROR | PMERROR | PERROR
| APERROR | PPERROR | RHO | FERROR | OOFFSET | STABLE
| TSNUMBER | SSCHANNEL | SCGRROUP | SCNUMBER | TLENGTH
| PCDE | CEVM | CMERROR | CPERROR | CHRO | COOF
| AGSCOPE | AGVALUE | RGRANT | ANACK }

Arguments Information queried is listed below for each of the arguments:

Table 3-13: Queried information on the 3GPP-R6 downlink analysis results

Argument	Information queried
CCODE	Power of each channelization code for the specified TS
CSYMBOL	Each symbol power of the specified TS/SC
CTSLOT	Power of each time slot for the specified SC
SCNSTE	Symbol position data for the specified TS/SC
EVM	Measurement results of Error Vector Magnitude for the specified TS/SC
AEVM	RMS value of EVM for the specified TS/SC
PEVM	Peak value of EVM for the specified TS/SC and its symbol number
MERROR	Amplitude error for the specified TS/SC
AMERROR	RMS value of amplitude error for the specified TS/SC
PMERROR	Peak amplitude error for the specified TS/SC and its symbol number
PERROR	Phase error for the specified TS/SC
APERROR	RMS value of phase error for the specified TS/SC
PPERROR	Peak phase error for the specified TS/SC and its symbol number
RHO	Value of waveform quality (ρ) for the specified TS/SC
FERROR	Frequency error for the specified TS
OOFFSET	Value of origin offset for the specified TS/SC
STABLE	Data from symbol table for the specified TS/SC
TSNUMBER	Slot number in radio frame for the specified TS
SSCHANNEL	Secondary Synchronization Channel (SSCH) number for the specified TS
SCGRROUP	Scrambling code group for the specified TS
SCNUMBER	Scrambling code number for the specified TS
TLENGTH	Number of analyzed TSs
PCDE	PCDE (Peak Code Domain Error) for the specified TS, and the SC number
CEVM	RMS and peak values of chip EVM for the specified TS
CMERROR	RMS and peak values of chip amplitude error for the specified TS
CPERROR	RMS and peak values of chip phase error for the specified TS
CHRO	Chip waveform quality (ρ) for the specified TS
COOF	Chip origin offset for the specified TS
AGSCOPE	Absolute Grant Scope
AGVALUE	Absolute Grant Value

Table 3-13: Queried information on the 3GPP-R6 downlink analysis results

Argument	Information queried
RGRant	Relative Grant
ANACK	ACK/NACK

* TS: Time slot; SC: Short code

To specify the time slot, use the :DISPlay:DLR6_3GPP:AVIew:TSLot command.
To specify the channelization code, use the :DISPlay:DLR6_3GPP:AVIew:CCODE command.

Returns Returns are listed below for each of the arguments. You can select degrees or radians for the angular unit using the :UNIT:ANGLE command.

CCODE.

```
#<Num_digit><Num_byte><Cpwr(1)><Cpwr(2)>...<Cpwr(n)>
```

Where

<Num_digit> is the number of digits in <Num_byte>.

<Num_byte> is the number of bytes of the data that follow.

<Cpwr(n)> is the relative or absolute power value for each short code in dB or dBm. 4-byte little endian floating-point format specified in IEEE 488.2.

n: Max 512

CSYMBOL.

```
#<Num_digit><Num_byte><Cpwr(1)><Cpwr(2)>...<Cpwr(n)>
```

Where

<Num_digit> is the number of digits in <Num_byte>.

<Num_byte> is the number of bytes of the data that follow.

<Cpwr(n)> is the relative or absolute power value for each symbol in dB or dBm. 4-byte little endian floating-point format specified in IEEE 488.2.

n: Max 640

CTSLot.

```
#<Num_digit><Num_byte><Cpwr(1)><Cpwr(2)>...<Cpwr(n)>
```

Where

<Num_digit> is the number of digits in <Num_byte>.

<Num_byte> is the number of bytes of the data that follow.

<Cpwr(n)> is the relative or absolute power value for each time slot in dB or dBm. 4-byte little endian floating-point format specified in IEEE 488.2.

n: Max 16000

SCONste.

#<Num_digit><Num_byte><Ip(1)><Qp(1)>...<Ip(n)><Qp(n)>

Where

<Num_digit> is the number of digits in <Num_byte>.

<Num_byte> is the number of bytes of the data that follow.

<Ip(n)> is the symbol position on the I axis in volt.

<Qp(n)> is the symbol position on the Q axis in volt.

Both <Ip(1)> and <Qp(1)> are in the 4-byte little endian floating-point format specified in IEEE 488.2. n: Max 640.

EVM. #<Num_digit><Num_byte><Evm(1)><Evm(2)>...<Evm(n)>

Where

<Num_digit> is the number of digits in <Num_byte>.

<Num_byte> is the number of bytes of the data that follow.

<Evm(n)> is the value of EVM of symbol in percent (%).

4-byte little endian floating-point format specified in IEEE 488.2

n: Max 640

AEVM. <aevm> : :=<NRf> is the EVM RMS value in percent (%).

PEVM. <pevm> , <symb>

Where

<pevm><NRf> is the EVM peak value in percent (%).

<symb> : :=<NR1> is the symbol number for the EVM peak value.

MERRor.

#<Num_digit><Num_byte><Merr(1)><Merr(2)>...<Merr(n)>

Where

<Num_digit> is the number of digits in <Num_byte>.

<Num_byte> is the number of bytes of the data that follow.

<Merr(n)> is the value of amplitude error of symbol in percent (%).

4-byte little endian floating-point format specified in IEEE 488.2

n: Max 640

AMERror. <amer> : :=<NRf> is the amplitude error RMS value in percent (%).

PMERror. <pmer> , <symb>

Where

<pmer> : :=<NRf> is the amplitude error peak value in percent (%).

<symb> : :=<NR1> is the symbol number for the amplitude error peak value.

PERRor.

#<Num_digit><Num_byte><Perr(1)><Perr(2)>...<Perr(n)>

Where

<Num_digit> is the number of digits in <Num_byte>.

<Num_byte> is the number of bytes of the data that follow.

<Perr(n)> is the value of phase error of symbol in degrees or radians.

4-byte little endian floating-point format specified in IEEE 488.2

n: Max 640

APERror. <pmer> ::= <NRf> is the phase error RMS value in degrees or radians.**PPERror.** <pmer>, <symb>**Where**

<pmer> ::= <NRf> is the phase error peak value in degrees or radians.

<symb> ::= <NRf> is the symbol number of phase error peak value.

RHO. <rho> ::= <NRf> is the measured value of waveform quality.**FERRor.** <ferr> ::= <NRf> is the measured value of frequency error in Hz.**OOFFset.** <ooff> ::= <NRf> is the measured value of origin offset in dB.**STABLE.**

#<Num_digit><Num_byte><Sym(1)><Sym(2)>...<Sym(n)>

Where

<Num_digit> is the number of digits in <Num_byte>.

<Num_byte> is the number of bytes of the data that follow.

<Sym(n)> ::= <NR1> is the symbol data.

n: Max 640.

TSNumber. <tsnum> ::= <NR1> is the slot number in radio frame.**SSCHannel.** <ssch> ::= <NR1> is the Secondary Synchronization Channel (SSCH) number.**SCGRoup.** <scgr> ::= <NR1> is the scrambling code group.**SCNumber.** <scnum> ::= <NR1> is the scrambling code number.**TLENgth.** <tlen> ::= <NR1> is the number of analyzed time slots.**PCDE.** <pcde>, <scod>**Where**

<pcde> ::= <NRf> is the PCDE (Peak Code Domain Error) value in dB.

<scod> ::= <NRf> is the short code number for the PCDE

CEVM. <cevma>, <cevmp>

Where

<cevma> ::= <NRf> is the RMS value of chip EVM in percent (%).

<cevmp> ::= <NRf> is the peak value of chip EVM in percent (%).

CMERror. <cmera>, <cmerp>

Where

<cmera> ::= <NRf> is the RMS value of chip amplitude error in percent (%).

<cmerp> ::= <NRf> is the peak value of chip amplitude error in percent (%).

CPError. <cpera>, <cperp>

Where

<cpera> ::= <NRf> is the RMS value of chip phase error in degrees or radians.

<cperp> ::= <NRf> is the peak value of chip phase error in degrees or radians.

CRHO. <crho> ::= <NRf> is the chip waveform quality (ρ).

COOF. <coof> ::= <NRf> is the chip origin offset in dB.

AGSCope. <agsc> ::= <NR1> is the Absolute Grant Scope (0 or 1).

AGValue. <agv> ::= <NR1> is the Absolute Grant value (0 to 31).

RGRant. <rgr> ::= <NR1> is Relative Grant value.

1 (UP), 0 (Hold), or -1 (DOWN).

ANACK. <anac> ::= <NR1> is the ACK/NACK value.

1 (ACK), 0 (NACK0), or -1 (NACK1).

NACK0: NACK (RLSs not containing the serving E-DCH cell)

NACK1: NACK (RLS containing the serving E-DCH cell)

Measurement Modes DEMDLR6_3G

Examples :FETCh:DLR6_3GPP? CShortcode
might return #3512xxxx... (512-byte data) for the power measurement results
for each short code.

Related Commands :DISPlay:DLR6_3GPP:AVIew:SHORtcode,
:DISPlay:DL3DLR6_3GPPGpp:AVIew:TSLot,
:INSTrument[:SElect], :UNIT:ANGLE

:FETCh:ULR6_3GPP? (Query Only)

Returns measurement results of the 3GPP-R6 uplink analysis.

Syntax :FETCh:ULR6_3GPP? { ANACk | CNUMber | CSYMBol | CTSLot | SCONste | EVM | AEVM | PEVM | MERRor | AMERRor | PMERRor | PERRor | APERRor | PPERror | RHO | FERRor | OOFFset | STABLE | TSNumber | SSCHannel | SCGRoup | SCNumber | TLENgth | PCDE | CEVM | CMERRor | CPERror | CHRO | COOF | PDIScont | TFCI | TPC | ETFCi | HAPPy | CINformation }

Arguments Information queried is listed below for each of the arguments:

Table 3-14: Queried information on the 3GPP-R6 uplink analysis results

Argument	Information queried
ANACk	ACK/NACK
CNUMber	Power of each channelization code for the specified TS
CSYMBol	Each symbol power of the specified TS/SC
CTSLot	Power of each time slot for the specified SC
SCONste	Symbol position data for the specified TS/SC
EVM	Measurement results of Error Vector Magnitude for the specified TS/SC
AEVM	RMS value of EVM for the specified TS/SC
PEVM	Peak value of EVM for the specified TS/SC and its symbol number
MERRor	Amplitude error for the specified TS/SC
AMERRor	RMS value of amplitude error for the specified TS/SC
PMERRor	Peak amplitude error for the specified TS/SC and its symbol number
PERRor	Phase error for the specified TS/SC
APERRor	RMS value of phase error for the specified TS/SC
PPERror	Peak phase error for the specified TS/SC and its symbol number
RHO	Value of waveform quality (ρ) for the specified TS/SC
FERRor	Frequency error for the specified TS
OOFFset	Value of origin offset for the specified TS/SC
STABLE	Data from symbol table for the specified TS/SC
TSNumber	Slot number in radio frame for the specified TS
SSCHannel	Secondary Synchronization Channel (SSCH) number for the specified TS
SCGRoup	Scrambling code group for the specified TS
SCNumber	Scrambling code number for the specified TS
TLENgth	Number of analyzed TSs
PCDE	PCDE (Peak Code Domain Error) for the specified TS, and the SC number
CEVM	RMS and peak values of chip EVM for the specified TS
CMERRor	RMS and peak values of chip amplitude error for the specified TS
CPERRor	RMS and peak values of chip phase error for the specified TS
CRHO	Chip waveform quality (ρ) for the specified TS
COOF	Chip origin offset for the specified TS

CNUMber.

When :DISPlay:ULR6_3GPP:AVIew:FORMat is set to CHANnel.

```
#<Num_digit><Num_byte><Cpwr(1)><Cpwr(2)>...<Cpwr(13)>
```

Where

<Num_digit> is the number of digits in <Num_byte>.

<Num_byte> is the number of bytes of data that follow.

<Cpwr(n)> is the relative or absolute power value for each channelization code in dB or dBm. 4-byte little endian floating-point format specified in IEEE 488.2.

When :DISPLay:ULR6_3GPP:AVIew:FORMat is set to IQSplit and :DISPlay:ULR6_3GPP:AVIew:IQBranch is set to I or Q.

```
#<Num_digit><Num_byte><Cpwr(1)><Cpwr(2)>...<Cpwr(n)>
```

Where

<Num_digit> is the number of digits in <Num_byte>.

<Num_byte> is the number of bytes of data that follow.

<Cpwr(n)> is the relative or absolute power value for each channelization code in dB or dBm. 4-byte little endian floating-point format specified in IEEE 488.2.

n: Max 256.

When :DISPLay:ULR6_3GPP:AVIew:FORMat is set to IQSplit and :DISPlay:ULR6_3GPP:AVIew:IQBranch is set to BOTH.

```
#<Num_digit><Num_byte><ICpwr(1)><QCpwr(1)>  
<ICpwr(2)><QCpwr(2)>...<ICpwr(n)><QCpwr(n)>
```

Where

<Num_digit> is the number of digits in <Num_byte>.

<Num_byte> is the number of bytes of data that follow.

<ICpwr(n)><QCpwr(n)> are the relative or absolute power values of I and Q components for each channelization code in dB or dBm.

4-byte little endian floating-point format specified in IEEE 488.2.

n: Max 256.

CSYMBOL.

```
#<Num_digit><Num_byte><Cpwr(1)><Cpwr(2)>...<Cpwr(n)>
```

Where

<Num_digit> is the number of digits in <Num_byte>.

<Num_byte> is the number of bytes of the data that follow.

<Cpwr(n)> is the relative or absolute power value for each symbol in dB or dBm. 4-byte little endian floating-point format specified in IEEE 488.2.

n: Max 640

CTSLot.

#<Num_digit><Num_byte><Cpwr(1)><Cpwr(2)>...<Cpwr(n)>

Where

<Num_digit> is the number of digits in <Num_byte>.

<Num_byte> is the number of bytes of the data that follow.

<Cpwr(n)> is the relative or absolute power value for each time slot in dB or dBm. 4-byte little endian floating-point format specified in IEEE 488.2.

n: Max 16000

SCONste.

#<Num_digit><Num_byte><Ip(1)><Qp(1)>...<Ip(n)><Qp(n)>

Where

<Num_digit> is the number of digits in <Num_byte>.

<Num_byte> is the number of bytes of the data that follow.

<Ip(n)> is the symbol position on the I axis in volt.

<Qp(n)> is the symbol position on the Q axis in volt.

Both <Ip(1)> and <Qp(1)> are in the 4-byte little endian floating-point format specified in IEEE 488.2. n: Max 640.

EVM. #<Num_digit><Num_byte><Evm(1)><Evm(2)>...<Evm(n)>

Where

<Num_digit> is the number of digits in <Num_byte>.

<Num_byte> is the number of bytes of the data that follow.

<Evm(n)> is the value of EVM of symbol in percent (%).

4-byte little endian floating-point format specified in IEEE 488.2

n: Max 640

AEVM. <aevm> : :=<NRf> is the EVM RMS value in percent (%).

PEVM. <pevm> , <symb>

Where

<pevm><NRf> is the EVM peak value in percent (%).

<symb> : :=<NR1> is the symbol number for the EVM peak value.

MERRor.

#<Num_digit><Num_byte><Merr(1)><Merr(2)>...<Merr(n)>

Where

<Num_digit> is the number of digits in <Num_byte>.

<Num_byte> is the number of bytes of the data that follow.

<Merr(n)> is the value of amplitude error of symbol in percent (%).

4-byte little endian floating-point format specified in IEEE 488.2

n: Max 640

AMERror. <amer> : :=<NRf> is the amplitude error RMS value in percent (%).

PMERror. <pmer>,<symb>

Where

<pmer> ::= <NRf> is the amplitude error peak value in percent (%).

<symb> ::= <NR1> is the symbol number for the amplitude error peak value.

PERRor.

#<Num_digit><Num_byte><Perr(1)><Perr(2)>...<Perr(n)>

Where

<Num_digit> is the number of digits in <Num_byte>.

<Num_byte> is the number of bytes of the data that follow.

<Perr(n)> is the value of phase error of symbol in degrees or radians.

4-byte little endian floating-point format specified in IEEE 488.2

n: Max 640

APERror. <pmer> ::= <NRf> is the phase error RMS value in degrees or radians.

PPERror. <pmer>,<symb>

Where

<pmer> ::= <NRf> is the phase error peak value in degrees or radians.

<symb> ::= <NRf> is the symbol number of phase error peak value.

RHO. <rho> ::= <NRf> is the measured value of waveform quality.

FERRor. <ferr> ::= <NRf> is the measured value of frequency error in Hz.

OOFFset. <ooff> ::= <NRf> is the measured value of origin offset in dB.

STABLE.

#<Num_digit><Num_byte><Sym(1)><Sym(2)>...<Sym(n)>

Where

<Num_digit> is the number of digits in <Num_byte>.

<Num_byte> is the number of bytes of the data that follow.

<Sym(n)> ::= <NR1> is the symbol data.

n: Max 640.

TSNumber. <tsnum> ::= <NR1> is the slot number in radio frame.

SSCHannel. <ssch> ::= <NR1> is the Secondary Synchronization Channel (SSCH) number.

SCGRoup. <scgr> ::= <NR1> is the scrambling code group.

SCNumber. <scnum> ::= <NR1> is the scrambling code number.

TLENgth. <tlen> ::= <NR1> is the number of analyzed time slots.

PCDE. <pcde>,<scod>

Where

<pcde> ::= <NRf> is the PCDE (Peak Code Domain Error) value in dB.

<scod> ::= <NRf> is the short code number for the PCDE

CEVM. <cevma>,<cevmp>

Where

<cevma> ::= <NRf> is the RMS value of chip EVM in percent (%).

<cevmp> ::= <NRf> is the peak value of chip EVM in percent (%).

CMERror. <cmera>,<cmerp>

Where

<cmera> ::= <NRf> is the RMS value of chip amplitude error in percent (%).

<cmerp> ::= <NRf> is the peak value of chip amplitude error in percent (%).

CPError. <cpera>,<cperp>

Where

<cpera> ::= <NRf> is the RMS value of chip phase error in degrees or radians.

<cperp> ::= <NRf> is the peak value of chip phase error in degrees or radians.

CRHO. <crho> ::= <NRf> is the chip waveform quality (ρ).

COOF. <coof> ::= <NRf> is the chip origin offset in dB.

SIGNature. <coof> ::= <NR1> is the signature number in preamble.

PDIScontinuity. <coof> ::= <NR1> is the phase discontinuity in degrees or radians.

TFCI. <tfci> ::= <NR1> is the TFCI value (0 to 1023).

TPC. <tpc> ::= <NR1> is the TPC value (0 or 1).

ETFCi. <tpc> ::= <NR1> is the E-TFCI value (0 to 127).

RSN. <rsn> ::= <NR1> is the RSN value (0 to 3).

HAPPy. <happy> ::= <NR1> is the Happy bit value (0 or 1).

CINFormation.

When *:DISPlay:ULR6_3GPP:AVIew:FORMat* is set to *CHANnel*.

<CInfo> ::= <string> is the channel information.

When *:DISPlay:ULR6_3GPP:AVIew:FORMat* is set to *IQSPlit*.

<ICInfo>, <QCInfo>

Where

<ICInfo> ::= <string> is the channel information on the I branch.

<QCInfo> ::= <string> is the channel information on the Q branch.

Measurement Modes DEMULR6_3G

Examples :FETCh:ULR6_3GPP? CNUMber
might return #3256xxxx... (256-byte data) for the power of each channelization code.

Related Commands :DISPlay:ULR6_3GPP:AVIew:CCODE,
:DISPlay:ULR6_3GPP:AVIew:CNUMBER,
:DISPlay:ULR6_3GPP:AVIew:FORMat,
:DISPlay:ULR6_3GPP:AVIew:TSLot, :INSTrument[:SElect],
:UNIT:ANGLe

:MMEMory Commands

The :MMEMory commands allow you to manipulate files on the hard disk or floppy disk.

For details on file manipulation, refer to the *WCA230A & WCA280A User Manual*.

Command Tree

Header	Parameter
:MMEMory	
:LOAD	
:LIMit	<file_name>
:STORe	
:LIMit	<file_name>
:RESult	<file_name>
:ITEM	CDPower CPSYmbol SEVM STABle MACCuracy
:MCONtent	EVM MERRor PERRor ALL
[:SElect]	<file_name>
:TSLot	
:NUMBer	<numeric_value>
:OFFSet	<numeric_value>
:STABle	<file_name>

:MMEMory:LOAD:LIMit (No Query Form)

Loads limits from the specified file.
This command is valid only in the S/A (spectrum analysis) mode.

Syntax :MMEMory:LOAD:LIMit <file_name>

Arguments <file_name>:=<string> specifies the file from which to load limits.
The file extension is .lmt.

Measurement Modes SADLR5_3G, SAULR5_3G

Examples :MMEMory:LOAD:LIMit "C:\My Documents\Test.lmt"
loads limits from the file Test.lmt in the My Documents folder.

:MMEMory:STORe:LIMit (No Query Form)

Stores the current limits in the specified file.
This command is valid only in the S/A (spectrum analysis) mode.

Syntax :MMEMory:STORe:LIMit <file_name>

Arguments <file_name>:=<string> specifies the file in which to store the current limits. The file extension is .lmt.

Measurement Modes SADLR5_3G, SAULR5_3G

Examples :MMEMory:STORe:LIMit "C:\My Documents\Test.lmt"
stores the current limits in the file Test.lmt in the My Documents folder.

:MMEMory:STORe:RESult:ITEM(?)

Selects or queries the measurement item to store.

Syntax :MMEMory:STORe:RESult:ITEM
 { CDPower | CPSYmbol | SEVM | STABle | MACCuracy }
 :MMEMory:STORe:RESultITEM?

Arguments The table 3-15 shows the measurement items.

Table 3-15: Item to save

Argument	Description
CDPower	Code domain power
CPSYmbol	Code domain power versus Symbol
SEVM	Symbol EVM
STABle	Symbol table
MACCuracy	Modulation accuracy

Measurement Modes DEMDLR6_3G, DEMULR6_3G

Examples :MMEMory:STORe:RESult:ITEM CDPower
 selects the code domain power measurement to store the result.

:MMEMory:STORe:RESult:MCONtent(?)

Selects or queries the measurement content in the symbol EVM measurement.
This command is valid when :MMEMory:STORe:RESult:ITEM is set to SEVM.

Syntax :MMEMory:STORe:RESult:MCONtent
{ EVM | MERRor | PERRor | ALL }

:MMEMory:STORe:RESult:MCONtent?

Arguments The table 3-16 shows the measurement contents.

Table 3-16: Content to save

Argument	Description
EVM	Symbol EVM
MERRor	Symbol amplitude error
PERRor	Symbol phase error
ALL	All of the above

Measurement Modes DEMDLR6_3G, DEMULR6_3G

Examples :MMEMory:STORe:RESult:MCONtent EVM
selects the symbol EVM as the measurement content.

:MMEMory:STORe:RESult[:SElect] (No Query Form)

Stores the measurement results in the specific file. The measurement item is selected by the :MMEMory:STORe:RESultITEM command.

Syntax :MMEMory:STORe:RESult[:SElect] <file_name>

:MMEMory:STORe:RESul[:SElect]?

Arguments <file_name>::=<string> specifies the file to store the measurement results. The file extension is .csv.

Measurement Modes DEMDLR6_3G, DEMULR6_3G

Examples :MMEMory:STORe:RESult:SElect "C:\My Documents\Test.csv"
stores the measurement results in the Test.csv file in the My Documents folder.

Related Commands :MMEMory:STORe:RESultITEM

:MMEMory:STORe:TSLot:OFFSet(?)

Sets or queries the first time-slot for storing the measurement results.

Syntax :MMEMory:STORe:RESult:TSLot:OFFSet <value>

:MMEMory:STORe:RESult:TSLot:OFFSet?

Arguments <value>::=<NRf> specifies the time-slot offset.
Range: -[(the number of time slots in the analysis range) - 1] to 0.
Zero (0) represents the latest slot.

Measurement Modes DEMDLR6_3G, DEMULR6_3G

Examples :MMEMory:STORe:RESult:TSLot:OFFSet -10
sets the first time-slot to #-10.

:MMEMory:STORe:TSLot:NUMBer(?)

Sets or queries the number of time slots for storing the measurement results.

Syntax :MMEMory:STORe:RESuLt:TSLot:NUMBer <number>

:MMEMory:STORe:RESuLt:TSLot:NUMBer?

Arguments <number>::=<NR1> specifies the number of time-slots.
Range: 1 to $-(\text{time-slot offset}) + 1$.

Measurement Modes DEMDLR6_3G, DEMULR6_3G

Examples :MMEMory:STORe:RESuLt:TSLot:NUMBer 12
sets the number of time slots to 12.

Related Commands :MMEMory:STORe:RESuLt:TSLot:OFFSet

:MMEMory:STORe:STABle (No Query Form)

Stores the symbol table in the specified file.
This command is valid only in the Demod (modulation analysis) mode.

Syntax :MMEMory:STORe:STABle <file_name>

Arguments <file_name>: :=<string> specifies the file to store the symbol table.
The file is in text format with its extension of .sym.

The header of the file has the following information in this order:

- Date and time
- Modulation
- Symbol rate
- Measurement filter
- Reference filter
- Filter factor (α)
- Slot number
- Channelization code number
- Time from the data end point of the first symbol

Measurement Modes DEMDLR5_3G, DEMULR5_3G

Examples :MMEMory:STORe:STABle "C:\My Documents\Data1.sym"
stores the symbol table in the file Data1.sym in the My Documents folder.

:SENSE Commands

The :SENSE commands set the details for each of the measurement sessions. They are divided into the following subgroups:

Table 3-17: :SENSE command subgroups

Command header	Function	Refer to:
[:SENSE]:DLR6_3GPP	Set up the modulation analysis for 3GPP-R6 downlink.	page 3-78
[:SENSE]:ULR6_3GPP	Set up the modulation analysis for 3GPP-R6 uplink.	page 3-91

[[:SENSe]:DLR6_3GPP Subgroup

The [[:SENSe]:DLR6_3GPP commands set up conditions for the 3GPP-R6 downlink modulation analysis.

NOTE. To use a command of this group, you must have selected *DEMDLR6_3G* (3GPP-R6 downlink modulation analysis mode) with the *:INSTRument[:SElect]* command.

Command Tree	Header	Parameter
	[[:SENSe]	
	:DLR6_3GPP	
	:BLOCK	<numeric_value>
	:CARRier	
	:OFFSet	<frequency>
	:SEARCh	<boolean>
	:CCODE	
	:EAGCh	<numeric_value>
	:ERGCh	<numeric_value>
	:COMPOSITE	<boolean>
	:DTYPE	
	:SEARCh	<boolean>
	:EVM	
	:IQOffset	INCLude EXCLude
	:FILTer	
	:ALPHa	<ratio>
	:MEASurement	OFF RRCosine
	:REFerence	OFF RCOSine GAUSSian
	[[:IMMediate]	
	:LENGth	<numeric_value>
	:OFFSet	<numeric_value>
	:SCHPart	<boolean>
	:SCODE	
	:ALTerNative	NUSed PRIMary LEFT RIGHT
	:NUMBer	<code_number>
	:SEARCh	<boolean>
	:SSINDEX	
	:EHICH	<numeric_value>
	:ERGCh	<numeric_value>
	:UTSTable	

[:SENSe] :DLR6_3GPP :BLOCK (?)

Sets or queries the number of the block to measure in the 3GPP-R6 downlink analysis.

Syntax [:SENSe] :DLR6_3GPP :BLOCK <number>

[:SENSe] :DLR6_3GPP :BLOCK ?

Arguments <number> : := <NR1> specifies the block number.
Zero represents the latest block.
Range: -M to 0 (M: Number of acquired blocks).

Measurement Modes DEMDLR6_3G

Examples :SENSe :DLR6_3GPP :BLOCK -5
sets the block number to -5.

[[:SENSe]:DLR6_3GPP:CARRier:OFFSet(?)]

Sets or queries the carrier frequency offset in the 3GPP-R6 downlink analysis.

Syntax `[[:SENSe]:DLR6_3GPP:CARRier:OFFSet <freq>`

`[[:SENSe]:DLR6_3GPP:CARRier:OFFSet?`

Arguments `<freq> ::= <NRf>` specifies the carrier frequency offset.
Range: $-F_s$ to F_s (F_s : Span)

Measurement Modes DEMDLR6_3G

Examples `:SENSe:DLR6_3GPP:CARRier:OFFSet 10MHz`
sets the carrier frequency offset to 10 MHz.

[[:SENSe]:DLR6_3GPP:CARRier:SEARch(?)]

Determines whether to detect the carrier automatically in the 3GPP-R6 downlink analysis.

Syntax `[[:SENSe]:DLR6_3GPP:CARRier:SEARch { OFF | ON | 0 | 1 }`

`[[:SENSe]:DLR6_3GPP:CARRier:SEARch?`

Arguments OFF or 0 specifies that the carrier is not detected automatically. Set the carrier frequency offset using the `[[:SENSe]:DLR6_3GPP:CARRier:OFFSet` command.

ON or 1 specifies that the carrier is detected automatically.

Measurement Modes DEMDLR6_3G

Examples `:SENSe:DLR6_3GPP:CARRier:SEARch ON`
specifies that the carrier is detected automatically.

Related Commands `[[:SENSe]:DLR6_3GPP:CARRier:OFFSet`

[:SENSe] :DLR6_3GPP :CCODE :EAGCh (?)

Sets or queries the channelization code number of E-AGCH in the 3GPP-R6 downlink analysis.

Syntax [:SENSe] :DLR6_3GPP :CCODE :EAGCh <number>

[:SENSe] :DLR6_3GPP :CCODE :EAGCh ?

Arguments <number> : := <NR1> specifies the channelization code number of E-AGCH. Range: 0 to 127.

Measurement Modes DEMDLR6_3G

Examples :SENSe :DLR6_3GPP :CCODE :EAGCh 85
sets the channelization code number to 85.

[:SENSe] :DLR6_3GPP :CCODE :ERGCh (?)

Sets or queries the channelization code number of E-RGCH and E-HICH in the 3GPP-R6 downlink analysis.

Syntax [:SENSe] :DLR6_3GPP :CCODE :ERGCh <number>

[:SENSe] :DLR6_3GPP :CCODE :ERGCh ?

Arguments <number> : := <NR1> specifies the channelization code number of E-RGCH and E-HICH. Range: 0 to 127.

Measurement Modes DEMDLR6_3G

Examples :SENSe :DLR6_3GPP :CCODE :ERGCh 28
sets the channelization code number to 28.

[[:SENSe]:DLR6_3GPP:COMPOSITE(?)]

Determines whether to perform the composite analysis (automatic detection of symbol rate) in the 3GPP-R6 downlink analysis.

Syntax [[:SENSe]:DLR6_3GPP:COMPOSITE { OFF | ON | 0 | 1 }

[[:SENSe]:DLR6_3GPP:COMPOSITE?

Arguments OFF or 0 specifies that composite analysis is not performed.

ON or 1 specifies that composite analysis is performed.

NOTE. You should usually specify that composite analysis is performed. If a normal analysis does not result, select *OFF* in this command and select a specific symbol rate in :DISPlay:DLR6_3GPP:AVIEW:SRATE.

Measurement Modes DEMDLR6_3G

Examples :SENSe:DLR6_3GPP:COMPOSITE ON
specifies that the composite analysis is performed.

Related Commands :DISPlay:DLR6_3GPP:AVIEW:SRATE

[[:SENSe]:DLR6_3GPP:DTYPE:SEARCH(?)]

Determines whether to detect the demodulation type of the code channel (QPSK or 16QAM) automatically.

Syntax [[:SENSe]:DLR6_3GPP:DTYPE:SEARCH { OFF | ON | 0 | 1 }

[[:SENSe]:DLR6_3GPP:DTYPE:SEARCH?

Arguments OFF or 0 specifies that the code channel is QPSK.

ON or 1 specifies that the code channel is automatically detected (QPSK or 16QAM).

Measurement Modes DEMDLR6_3G

Examples :SENSe:DLR6_3GPP:DTYPE:SEARCH ON
specifies that the code channel is automatically detected.

[:SENSe]:DLR6_3GPP:EVM:IQOffset(?)

Determines whether to include the I/Q origin offset in the EVM (Error Vector Magnitude), Rho (waveform quality), and PCDE (Peak Code Domain Error) calculation.

Syntax [:SENSe]:DLR6_3GPP:EVM:IQoffset { INCLude | EXCLude }

[:SENSe]:DLR6_3GPP:EVM:IQoffset?

Arguments INCLude includes the I/Q origin offset in the EVM, Rho, and PCDE calculation.

EXCLude excludes the I/Q origin offset from the calculation.

Measurement Modes DEMDLR6_3G

Examples :SENSe:DLR6_3GPP:EVM:IQoffset INCLude
includes the I/Q origin offset in the calculation.

[:SENSe]:DLR6_3GPP:FILTer:ALPHA(?)

Sets or queries the filter factor (α /BT) in the 3GPP-R6 downlink analysis.

Syntax [:SENSe]:DLR6_3GPP:FILTer:ALPHA <value>

[:SENSe]:DLR6_3GPP:FILTer:ALPHA?

Arguments <value> ::= <NRf> specifies the filter factor (α /BT). Range: 0 to 1.

Measurement Modes DEMDLR6_3G

Examples :SENSe:DLR6_3GPP:FILTer:ALPHA 0.5
sets the filter factor to 0.5.

[[:SENSe]:DLR6_3GPP:FILTer:MEASurement(?)]

Selects or queries the measurement filter in the 3GPP-R6 downlink analysis.

Syntax `[[:SENSe]:DLR6_3GPP:FILTer:MEASurement
{ OFF | RRCosine }`

`[[:SENSe]:DLR6_3GPP:FILTer:MEASurement?`

Arguments OFF specifies that no measurement filter is used.

RRCosine selects the Root Raised Cosine filter.

Measurement Modes DEMDLR6_3G

Examples `:SENSe:DLR6_3GPP:FILTer:MEASurement RRCosine`
selects the Root Raised Cosine filter as the measurement filter.

[[:SENSe]:DLR6_3GPP:FILTer:REFerence(?)]

Selects or queries the reference filter in the 3GPP-R6 downlink analysis.

Syntax `[[:SENSe]:DLR6_3GPP:FILTer:REFerence
{ OFF | RCOSine | GAUSSian }`

`[[:SENSe]:DLR6_3GPP:FILTer:REFerence?`

Arguments OFF specifies that no reference filter is used.

RCOSine selects the Raised Cosine filter.

GAUSSian selects the Gaussian filter.

Measurement Modes DEMDLR6_3G

Examples `:SENSe:DLR6_3GPP:FILTer:REFerence RCOSine`
selects the Raised Cosine filter as the reference filter.

[:SENSe]:DLR6_3GPP[:IMMediate] (No Query Form)

Runs the 3GPP-R6 downlink analysis calculation on the acquired data.
To acquire data, use the :INITiate command.

Syntax	[:SENSe]:DLR6_3GPP[:IMMediate]
Arguments	None
Measurement Modes	DEMDLR6_3G
Examples	:SENSe:DLR6_3GPP:IMMediate runs the 3GPP-R6 downlink analysis calculation.
Related Commands	:INITiate

[:SENSe]:DLR6_3GPP:LENGth(?)

Defines or queries the range for the 3GPP-R6 downlink analysis.

Syntax	[:SENSe]:DLR6_3GPP:LENGth <value> [:SENSe]:DLR6_3GPP:LENGth?
Arguments	<value> ::= <Nrf> specifies the analysis range by the number of data points. Range: 1 to 1024 × (block size). To set the block size, use the [:SENSe]:BSIZE command. For the [:SENSe]:BSIZE command, refer to the <i>WCA230A and WCA280A Programmer Manual</i> .
Measurement Modes	DEMDLR6_3G
Examples	:SENSe:DLR6_3GPP:LENGth 1000 sets the length of the analysis range to 1000 points.
Related Commands	[:SENSe]:BSIZE

[[:SENSe]:DLR6_3GPP:OFFSet(?)]

Sets or queries the measurement start position in the 3GPP-R6 downlink analysis.

Syntax [[:SENSe]:DLR6_3GPP:OFFSet <value>

[[:SENSe]:DLR6_3GPP:OFFSet?

Arguments <value>: :=<NRf> specifies the measurement start position by the number of data points. Range: 0 to $1024 \times (\text{block size}) - 1$.
To set the block size, use the [[:SENSe]:BSIZE] command. For the [[:SENSe]:BSIZE] command, refer to the *WCA230A and WCA280A Programmer Manual*.

Measurement Modes DEMDLR6_3G

Examples :SENSe:DLR6_3GPP:OFFSet 100
sets the measurement start position to point 100.

Related Commands [[:SENSe]:BSIZE]

[[:SENSe]:DLR6_3GPP:SCHPart(?)]

Determines whether to include the SCH part in the analysis.

Syntax [[:SENSe]:DLR6_3GPP:SCHPart { OFF | ON | 0 | 1 }

[[:SENSe]:DLR6_3GPP:SCHPart?

Arguments OFF or 0 specifies that the SCH part is not included in the analysis.

ON or 1 specifies that the SCH part is included in the analysis.

Measurement Modes DEMDLR6_3G

Examples :SENSe:DLR6_3GPP:SCHPart ON
specifies that the SCH part is included in the analysis.

[:SENSe] :DLR6_3GPP :SCODE :ALternative (?)

Selects or queries the alternative scrambling code in the 3GPP-R6 downlink modulation analysis.

Syntax [:SENSe] :DLR6_3GPP :SCODE :ALternative
{ NUSed | PRIMary | LEFT | RIGHT }

[:SENSe] :DLR6_3GPP :SCODE :ALternative ?

Arguments NUSed (default) uses the primary scrambling code only (without the left and the right alternative scrambling codes) to de-spread the input signal.

PRIMary uses the primary scrambling with the left and the right alternative scrambling codes to de-spread the input signal.

LEFT uses the left alternative scrambling code to de-spread the input signal.

RIGHT uses the right alternative scrambling code to de-spread the input signal.

Measurement Modes DEMDLR6_3G

Examples :SENSe :DLR6_3GPP :SCODE :ALternative RIGHT
uses the right alternative scrambling code to de-spread the input signal.

[:SENSe]:DLR6_3GPP:SCODE:NUMBER(?)

Sets or queries the scrambling code in the 3GPP-R6 downlink analysis.

Syntax [:SENSe]:DLR6_3GPP:SCODE:NUMBER <value>

[:SENSe]:DLR6_3GPP:SCODE:NUMBER?

Arguments <value> ::= <NR1> specifies the scrambling code. Range: 0 to 24575.

Measurement Modes DEMDLR6_3G

Examples :SENSe:DLR6_3GPP:SCODE:NUMBER 3
sets the scrambling code to 3.

Related Commands [:SENSe]:DLR6_3GPP:SCODE:SEARCH

[:SENSe]:DLR6_3GPP:SCODE:SEARCH(?)

Determines whether automatic detection of the scrambling code is on or off in the 3GPP-R6 downlink analysis.

Syntax [:SENSe]:DLR6_3GPP:SCODE:SEARCH { OFF | ON | 0 | 1 }

[:SENSe]:DLR6_3GPP:SCODE:SEARCH?

Arguments OFF or 0 specifies that the scrambling code is not detected automatically.
To set it, use the [:SENSe]:DLR6_3GPP:SCODE:NUMBER command above.

ON or 1 specifies that the scrambling code is detected automatically.

Measurement Modes DEMDLR6_3G

Examples :SENSe:DLR6_3GPP:SCODE:SEARCH ON
specifies that the scrambling code is detected automatically.

Related Commands [:SENSe]:DLR6_3GPP:SCODE:NUMBER

[:SENSe]:DLR6_3GPP:SSINdex:EHICH(?)

Sets or queries the signature sequence index number of E-HICH in the 3GPP-R6 downlink analysis.

Syntax [:SENSe]:DLR6_3GPP:CCODE:EGCh <number>

[:SENSe]:DLR6_3GPPCCODE:EGCh?

Arguments <number> : :=<NR1> specifies the signature sequence index number of E-HICH. Range: 0 to 39.

Measurement Modes DEMDLR6_3G

Examples :SENSe:DLR6_3GPP:CCODE:EGCh 12
sets the signature sequence index number to 12.

[:SENSe]:DLR6_3GPP:SSINdex:ERGCh(?)

Sets or queries the signature sequence index number of E-RGCH in the 3GPP-R6 downlink analysis.

Syntax [:SENSe]:DLR6_3GPP:CCODE:ERGCh <number>

[:SENSe]:DLR6_3GPPCCODE:ERGCh?

Arguments <number> : :=<NR1> specifies the signature sequence index number of E-RGCH. Range: 0 to 39.

Measurement Modes DEMDLR6_3G

Examples :SENSe:DLR6_3GPP:CCODE:ERGCh 12
sets the signature sequence index number to 12.

[:SENSe] :DLR6_3GPP :UTSTable (No Query Form)

Updates the time-slot table in the main view in the 3GPP-R6 downlink analysis.

Syntax [:SENSe] :DLR6_3GPP :UTSTable

Arguments None

Measurement Modes DEMDLR6_3G

Examples :SENSe :DLR6_3GPP :UTSTable
updates the time-slot table in the main view.

[:SENSe]:ULR6_3GPP Subgroup

The [:SENSe]:ULR6_3GPP commands set up conditions for the 3GPP-R6 uplink modulation analysis.

NOTE. To use a command of this group, you must have selected *DEMULR6_3G* (3GPP-R6 uplink modulation analysis mode) with the *:INSTrument[:SElect]* command.

Command Tree	Header	Parameter
	[:SENSe]	
	:ULR6_3GPP	
	:BLOCK	<numeric_value>
	:CARRier	
	:OFFSet	<frequency>
	:SEARCh	<boolean>
	:CCONfig	AUTO C1N C2N C3N
	:DFORmat	AUTO S0F S1F S2F S3F
	:EVM	
	:IQOoffset	INCLude EXCLude
	:TPERiods	INCLude EXCLude
	:FILTer	
	:ALPHa	<numeric_value>
	:MEASurement	OFF RRCosine
	:REFerence	OFF RCOsine GAUSSian
	[:IMMediate]	
	:LENGth	<numeric_value>
	:MMODE	DPCH PRACH PCPCh
	:OFFSet	<numeric_value>
	:SCODE	
	:NUMBer	<numeric_value>
	:TYPE	LONG SHORT
	:SFRame	
	:OFFSet	
	:DTIME	<numeric_value>
	[:STSLot]	<numeric_value>
	:SEARCh	AUTO STSLot DTIME
	:THReshold	
	[:BURSt]	<numeric_value>
	:DTX	<numeric_value>
	:TOLerance	<numeric_value>
	:UTSTable	

[:SENSe] :ULR6_3GPP :BLOCK (?)

Sets or queries the number of the block to measure in the 3GPP-R6 uplink analysis.

Syntax [:SENSe] :ULR6_3GPP :BLOCK <number>

[:SENSe] :ULR6_3GPP :BLOCK ?

Arguments <number> : := <NRf> specifies the block number.
Zero represents the latest block.
Range: -M to 0 (M: Number of acquired blocks)

Measurement Modes DEMULR6_3G

Examples :SENSe :ULR6_3GPP :BLOCK -5
sets the block number to -5.

[:SENSe] :ULR6_3GPP :CARRier :OFFSet (?)

Sets or queries the carrier frequency offset in the 3GPP-R6 uplink analysis.

Syntax [:SENSe] :ULR6_3GPP :CARRier :OFFSet <freq>

[:SENSe] :ULR6_3GPP :CARRier :OFFSet ?

Arguments <freq> : :=<NRf> specifies the carrier frequency offset.
Range: -Fs to Fs (Fs: Span)

Measurement Modes DEMULR6_3G

Examples :SENSe :ULR6_3GPP :CARRier :OFFSet 10MHz
sets the carrier frequency offset to 10 MHz.

[:SENSe] :ULR6_3GPP :CARRier :SEARch (?)

Determines whether to detect the carrier automatically in the 3GPP-R6 uplink analysis.

Syntax [:SENSe] :ULR6_3GPP :CARRier :SEARch { OFF | ON | 0 | 1 }

[:SENSe] :ULR6_3GPP :CARRier :SEARch ?

Arguments OFF or 0 specifies that the carrier is not detected automatically.
Set the carrier frequency offset using the
[:SENSe] :ULR6_3GPP :CARRier :OFFSet command.

ON or 1 specifies that the carrier is detected automatically.

Measurement Modes DEMULR6_3G

Examples :SENSe :ULR6_3GPP :CARRier :SEARch ON
specifies that the carrier is detected automatically.

Related Commands [:SENSe] :ULR6_3GPP :CARRier :OFFSet

[[:SENSe]:ULR6_3GPP:CCONfig(?)

Selects or queries the channel configuration (defined in the 3GPP-R6 standard).

Syntax [[:SENSe]:ULR6_3GPP:CCONfig { AUTO | C1N | C2N | C3N }
[[:SENSe]:ULR6_3GPP:CCONfig?

Arguments Table 3-18 lists the arguments.

Table 3-18: Configuration in 3GPP-R6

Argument	DPCCH format
AUTO	Detects the configuration automatically
C1N	Configuration #1
C2N	Configuration #2
C3N	Configuration #3

Measurement Modes DEMULR6_3G

Examples :SENSe:ULR6_3GPP:CCONfig C1N
selects Configuration #1.

[:SENSe]:ULR6_3GPP:DFORmat(?)

Selects or queries the DPCCH format to decode TFCI in the 3GPP-R6 uplink analysis.

Syntax [:SENSe]:ULR6_3GPP:DFORmat
{ AUTO | S0F | S1F | S2F | S3F }

[:SENSe]:ULR6_3GPP:DFORmat?

Arguments Table 1-28 lists the arguments.

Table 3-19: DPCCH format

Argument	DPCCH format
AUTO	Detects the format automatically
S0F	Slot Format #0 (including 0A and 0B)
S1F	Slot Format #1
S2F	Slot Format #2 (including 0A and 0B)
S3F	Slot Format #3

Measurement Modes DEMULR6_3G

Examples :SENSe:ULR6_3GPP:DFORmat S0F
selects Slot Format #0.

[:SENSe]:ULR6_3GPP:EVM:IQOoffset(?)

Determines whether to include the I/Q origin offset in the EVM (Error Vector Magnitude), Rho (waveform quality), and PCDE (Peak Code Domain Error) calculation.

Syntax [:SENSe]:ULR6_3GPP:EVM:IQOoffset { INCLude | EXCLude }

[:SENSe]:ULR6_3GPP:EVM:IQOoffset?

Arguments INCLude includes the I/Q origin offset in the EVM, Rho, and PCDE calculation.

EXCLude excludes the I/Q origin offset from the calculation.

Measurement Modes DEMULR6_3G

Examples :SENSe:ULR6_3GPP:IQOoffset INCLude
includes the I/Q origin offset in the calculation.

[[:SENSe]:ULR6_3GPP:EVM:TPERiods(?)

Determines whether to include the transient periods (both 25 μ s ends of the time slot) in the EVM (Error Vector Magnitude), Rho (waveform quality), and PCDE (Peak Code Domain Error) calculation.

Syntax [:SENSe]:ULR6_3GPP:EVM:TPERiods { INCLude | EXCLude }
[:SENSe]:ULR6_3GPP:EVM:TPERiods?

Arguments INCLude includes the transient periods in the EVM, Rho, and PCDE calculation.
EXCLude excludes the transient periods from the calculation.

Measurement Modes DEMULR6_3G

Examples :SENSe:ULR6_3GPP:TPERiods INCLude
includes the transient periods in the calculation.

[[:SENSe]:ULR6_3GPP:FILTer:ALPHa(?)

Sets or queries the filter factor (α /BT) for the measurement and the reference filters in the 3GPP-R6 uplink analysis.

Syntax [:SENSe]:ULR6_3GPP:FILTer:ALPHa <value>
[:SENSe]:ULR6_3GPP:FILTer:ALPHa?

Arguments <value>: :=<NRf> specifies the filter factor. Range: 0 to 1.

Measurement Modes DEMULR6_3G

Examples :SENSe:ULR6_3GPP:FILTer:ALPHa 0.5
sets the filter factor to 0.5.

[:SENSe]:ULR6_3GPP:FILTer:MEASurement(?)

Selects or queries the measurement filter in the 3GPP-R6 uplink analysis.

Syntax [:SENSe]:ULR6_3GPP:FILTer:MEASurement
{ OFF | RRCosine }

[:SENSe]:ULR6_3GPP:FILTer:MEASurement?

Arguments OFF specifies that no measurement filter is used.

RRCosine selects the Root Raised Cosine filter.

Measurement Modes DEMULR6_3G

Examples :SENSe:ULR6_3GPP:FILTer:MEASurement RRCosine
selects the Root Raised Cosine filter.

[:SENSe]:ULR6_3GPP:FILTer:REFerence(?)

Selects or queries the reference filter in the 3GPP-R6 uplink analysis.

Syntax [:SENSe]:ULR6_3GPP:FILTer:REFerence
{ OFF | RCOsine | GAUSSian }

[:SENSe]:ULR6_3GPP:FILTer:REFerence?

Arguments OFF specifies that no reference filter is used.

RCOsine selects the Raised Cosine filter.

GAUSSian selects the Gaussian filter.

Measurement Modes DEMULR6_3G

Examples :SENSe:ULR6_3GPP:FILTer:REFerence RCOsine
selects the Raised Cosine filter.

[[:SENSe]:ULR6_3GPP[:IMMediate] (No Query Form)

Runs the 3GPP-R6 uplink analysis calculation for the acquired data.
To acquire data, use the :INITiate command.

Syntax [:SENSe]:ULR6_3GPP[:IMMediate]

Arguments None

Measurement Modes DEMULR6_3G

Examples :SENSe:ULR6_3GPP:IMMediate
runs the 3GPP-R6 uplink analysis calculation.

Related Commands :INITiate

[:SENSe]:ULR6_3GPP:LENGth(?)

Defines or queries the range for the 3GPP-R6 uplink analysis.

Syntax [:SENSe]:ULR6_3GPP:LENGth <value>

[:SENSe]:ULR6_3GPP:LENGth?

Arguments <value> ::= <Nrf> specifies the analysis range by the number of data points. Range: 1 to 1024 × (block size).
To set the block size, use the [:SENSe]:BSIZe command. For the [:SENSe]:BSIZe command, refer to the *WCA230A and WCA280A Programmer Manual*.

Measurement Modes DEMULR6_3G

Examples :SENSe:ULR6_3GPP:LENGth 1000
sets the analysis range to 1000 points.

Related Commands [:SENSe]:BSIZe

[:SENSe]:ULR6_3GPP:MMOde(?)

Selects or queries the mobile mode in the 3GPP-R6 uplink analysis.

Syntax [:SENSe]:ULR6_3GPP:MMOde { DPCh | PRACH | PCPCh }

[:SENSe]:ULR6_3GPP:MMOde?

Arguments DPCh selects the DPDCH/DPCCH mode.

PRACH selects the PRACH mode.

PCPCh selects the PCPCH mode.

Measurement Modes DEMULR6_3G

Examples :SENSe:ULR6_3GPP:MMOde PRACH
selects the PRACH mode.

[[:SENSe]:ULR6_3GPP:OFFSet(?)]

Sets or queries the measurement start position in the 3GPP-R6 uplink analysis.

Syntax [[:SENSe]:ULR6_3GPP:OFFSet <value>

[[:SENSe]:ULR6_3GPP:OFFSet?

Arguments <value> ::= <NRf> specifies the measurement start position by the number of data points. Range: 0 to $1024 \times (\text{block size}) - 1$.
To set the block size, use the [[:SENSe]:BSIZE] command. For the [[:SENSe]:BSIZE] command, refer to the *WCA230A and WCA280A Programmer Manual*.

Measurement Modes DEMULR6_3G

Examples :SENSe:ULR6_3GPP:OFFSet 100
sets the measurement start position to point 100.

Related Commands [[:SENSe]:BSIZE]

[:SENSe] :ULR6_3GPP :SCODE :NUMBER (?)

Sets or queries the scrambling code in the 3GPP-R6 uplink analysis.

Syntax [:SENSe] :ULR6_3GPP :SCODE :NUMBER <value>

[:SENSe] :ULR6_3GPP :SCODE :NUMBER ?

Arguments <value> : = <NR1> specifies the scrambling code. Range: 0 to 16777215.

Measurement Modes DEMULR6_3G

Examples :SENSe :ULR6_3GPP :SCODE :NUMBER 3
sets the scrambling code to 3.

[:SENSe] :ULR6_3GPP :SCODE :TYPE (?)

Selects or queries the scrambling code type.

Syntax [:SENSe] :ULR6_3GPP :SCODE :TYPE { LONG | SHORT }

[:SENSe] :ULR6_3GPP :SCODE :TYPE ?

Arguments LONG selects the long code.

SHORT selects the short code.

Measurement Modes DEMULR6_3G

Examples :SENSe :ULR6_3GPP :SCODE :TYPE LONG
selects the long code.

Related Commands [:SENSe] :ULR6_3GPP :MMODE

[[:SENSe]:ULR6_3GPP:SFRame:OFFSet:DTIME(?]

Sets or queries the downlink time offset when [[:SENSe]:ULR6_3GPP:SFRame:SEARCh] is set to DLTIme. The downlink time offset is the time offset between the start of HS-SCCH and the start of DPCH.

Syntax [[:SENSe]:ULR6_3GPP:SFRame:OFFSet:DTIME <value>

[[:SENSe]:ULR6_3GPP:SFRame:OFFSet:DTIME?

Arguments <value>: :=<NRf> specifies the downlink time offset.
Range: 0 to 149 symbols.

Measurement Modes DEMULR6_3G

Examples :SENSe:ULR6_3GPP:SFRame:OFFSet:DTIME 35
sets the downlink time offset to 35 symbols.

Related Commands [[:SENSe]:ULR6_3GPP:SFRame:SEARCh

[[:SENSe]:ULR6_3GPP:SFRame:OFFSet[:STSLot](?]

Sets or queries the subframe to time-slot offset when [[:SENSe]:ULR6_3GPP:SFRame:SEARCh] is set to STSLot. The subframe to time-slot offset is the time offset between the start of the DPDCH time slot and the start of the HS-DPCCH subframe.

Syntax [[:SENSe]:ULR6_3GPP:SFRame:OFFSet[:STSLot] <value>

[[:SENSe]:ULR6_3GPP:SFRame:OFFSet[:STSLot]?

Arguments <value>: :=<NRf> specifies the subframe to time-slot offset.
Range: 0 to 9 symbols.

Measurement Modes DEMULR6_3G

Examples :SENSe:ULR6_3GPP:SFRame:OFFSet:STSLot 5
sets the subframe to time-slot offset to 5 symbols.

Related Commands [[:SENSe]:ULR6_3GPP:SFRame:SEARCh

[:SENSe] :ULR6_3GPP :SFRame :SEARch (?)

Determines whether to detect the subframe offset automatically in the 3GPP-R6 uplink analysis.

Syntax [:SENSe] :ULR6_3GPP :SFRame :SEARch
{ AUTO | STSLot | DTIME }

[:SENSe] :ULR6_3GPP :SFRame :SEARch?

Arguments AUTO specifies that the subframe offset is detected automatically (default).

STSLot specifies the subframe to time-slot offset.
Set the offset using the [:SENSe] :ULR6_3GPP :SFRame :OFFSet [:STSLot] command.

DTIME specifies the downlink time offset.
Set the offset using the [:SENSe] :ULR6_3GPP :SFRame :OFFSet :DTIME command.

Measurement Modes DEMULR6_3G

Examples :SENSe :ULR6_3GPP :SFRame :SEARch AUTO
specifies that the subframe offset is detected automatically.

Related Commands [:SENSe] :ULR6_3GPP :SFRame :OFFSet :DTIME,
[:SENSe] :ULR6_3GPP :SFRame :OFFSet [:STSLot]

[[:SENSe]:ULR6_3GPP:THReshold[:BURSt](?)

Sets or queries the threshold level to detect a burst. This command is valid when [:SENSe]:ULR6_3GPP:MMODE is set to PRACH.

Syntax [:SENSe]:ULR6_3GPP:THReshold[:BURSt] <value>

[:SENSe]:ULR6_3GPP:THReshold[:BURSt]?

Arguments <value>: :=<NRf> specifies the threshold level to detect a burst.
Range: -100 to 10 dB.

Measurement Modes DEMULR6_3G

Examples :SENSe:ULR6_3GPP:THReshold:BURSt -20
sets the threshold to -20 dB.

Related Commands [:SENSe]:ULR6_3GPP:MMODE

[[:SENSe]:ULR6_3GPP:THReshold:DTX(?)

Sets or queries the threshold level to detect the DTX state in the 3GPP-R6 uplink analysis.

Syntax [:SENSe]:ULR6_3GPP:THReshold:DTX <value>

[:SENSe]:ULR6_3GPP:THReshold:DTX?

Arguments <value>: :=<NRf> specifies the threshold level to detect the DTX state.
Range: -20 to 0 dB relative to the DPCCH power.

Measurement Modes DEMULR6_3G

Examples :SENSe:ULR6_3GPP:THReshold:DTX -5
sets the DTX threshold to -5 dB.

[:SENSe] :ULR6_3GPP:TOLerance(?)

Sets or queries the tolerance (number of symbols which are allowed to be different from the 3GPP-R6 specifications for decoding HS-DPCCH and E-DPCCH).

Syntax [:SENSe] :ULR6_3GPP:TOLerance <value>

[:SENSe] :ULR6_3GPP:TOLerance?

Arguments <value> ::= <Nrf> specifies the tolerance. Range: 0 to 5 symbols.

Measurement Modes DEMULR6_3G

Examples :SENSe:ULR6_3GPP:TOLerance 3
sets the tolerance to 3.

[:SENSe] :ULR6_3GPP:UTSTable (No Query Form)

Updates the time-slot table in the main view in the 3GPP-R6 uplink analysis.

Syntax [:SENSe] :ULR6_3GPP:UTSTable

Arguments None

Measurement Modes DEMULR6_3G

Examples :SENSe:ULR6_3GPP:UTSTable
updates the time-slot table in the main view.



Appendices

Appendix A: Scale Setting Range

This section lists the setting ranges of the horizontal and the vertical scales for the views used in the 3GPP-R6 analysis.

Table A-1: Display format and scale

Display format	Horizontal range	Vertical range
Spectrum	0 Hz to 8 GHz	-200 to +100 dBm
Spectrogram	0 Hz to 8 GHz	Frame -15999 to 0 Frame -63999 to 0 (Option 02)
Time domain view	$-(T_f \times N_f)$ to 0 s ¹	-200 to +100 dBm (Amplitude) -30 to +30 V (I/Q level) -300 to +300% (AM) -38.4 to +38.4 MHz (FM/FVT) -675 to +675 deg. (PM)
CDP ²	0 to 511 channels (downlink) 0 to 255 channels (uplink)	-200 to +100 dB/dBm
CDP spectrogram ²	0 to 511 channels (downlink) 0 to 255 channels (uplink)	Slot -3999 to 0 Slot -15999 to 0 (Option 02)
CDP vs. Symbol ²	0 to 639 symbols (downlink) 0 to 1279 symbols (uplink)	-200 to +100 dB/dBm
CDP vs. Time slot ²	Slot -3999 to 0 Slot -15999 to 0 (Option 02)	-200 to +100 dB/dBm
Symbol constellation ³	Fixed	Fixed
Symbol EVM	0 to 639 symbols (downlink) 0 to 1279 symbols (uplink)	-100 to +200% (EVM) -300 to +300% (amplitude error) -675 to +675 deg. (phase error)
Symbol eye diagram	0 to 639 symbols (downlink) 0 to 1279 symbols (uplink)	Fixed
Symbol table	0 to $(1024 \times N_f)$ symbols	NA

1. **T_f**: Frame time; **N_f**: Frame number

2. **CDP**: Code Domain Power

3. **The maximum number of symbols: 640 (downlink) / 1280 (uplink)**

Appendix B: Saving Measurement Results

You can save measurement results to files in the CSV (Comma Separated Values) format using the **SAVE** key on the front panel, allowing you to import the file into Microsoft Excel or other database systems. This section provides information about file save specific to Option 40 3GPP-R6 analysis. For details on standard file operations, refer to the *WCA230A and WCA280A User Manual*.

NOTE. *If the hard disk space is less than 10 MB, the software stops saving the measurement results.*

Save Menu

The Save menu for the 3GPP-R6 analysis has the following controls:

Save State. Saves the instrument settings.

Save Data... Saves the input waveform (IQ data in the time domain) to a file in the IQT format.

- **All Blocks.** Saves all the acquired blocks.
- **Current Block.** Saves the block currently displayed in the overview.
- **Current Area.** Saves the data in the analysis range.

Item... Select the measurement item to save.

- Code Domain Power
- Symbol Power
- Symbol EVM
- Symbol Table
- Modulation Accuracy

The saved file format is listed in the next section.

Time Slot Offset. Sets the start time-slot to save. (See Figure B-1.)
Range: $-\text{[(the number of time slots in the analysis range) - 1]}$ to 0.
Zero (0) represents the latest slot.

Number of Time Slots. Sets the number of time slots to save. (See Figure B-1.)
Range: 1 to $-\text{[(Time Slot Offset) + 1]}$ (up to 4000 time slots).

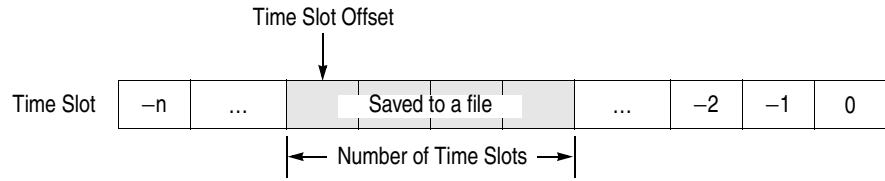

Figure B-1: Setting the time slots to save

Measurement Content... *Symbol EVM only.* Selects the measurement content.

- **EVM.** Selects EVM.
- **Mag Error.** Selects the magnitude error.
- **Phase Error.** Selects the phase error.
- **All.** Selects all of the above.

Filename... Specify a file name to save the results. For details on file operations, refer to the *WCA230A and WCA280A User Manual*.

Saved File Format

The file lists descriptions or measurement values under each header as shown in Figure B-2. The saved file format depends on measurements. The following subsections provide the format for each measurement.

	A	B	C	D	E	F	G
1	#Measurement	Code Domain Power					
2	#DateTime	#####					
3	#Timeslot Index	Timeslot No.	Total Power[dBm]	PSCH Power[dBm]	SSCH Power[dBm]	Code Power[dBm]	
4	-14	6	-11.5133	-44.7227	-26.7004	-27.5313	-27.523
5						0@SF256	1@SF256
6						-72.0156	-75.835
7						142@SF512	143@SF51:
8						-81.1641	-71.335
9						270@SF512	271@SF51:
10						-74.5391	-77.359
11						401@SF512	402@SF51:
12	-13	7	-11.5197	-31.5173	-32.9625	-27.5234	-27.546
13						0@SF256	1@SF256
14						-73.8438	-77.898
15						142@SF512	143@SF51:
16						-73.75	-70.578
17						270@SF512	271@SF51:
18						-76.3984	-74.296
19						401@SF512	402@SF51:
20	-12	8	-11.5164	-33.8998	-32.7139	-27.5391	-27.539
21						0@SF256	1@SF256
22						-73.4844	-73.039

Figure B-2: CSV file example (code domain power measurement)

Downlink This subsection shows the saved file format for the downlink measurements.

Code Domain Power. The saved file format depends on the setting of Symbol Rate in the View Define menu.

■ Symbol Rate: Composite

Header	Content
Measurement	Code domain power
Date Time	Date and time
Timeslot Index	Time slot serial number in the analysis range
Timeslot No.	Time slot number in the radio frame (0 to 14)
Total Power [dBm]	Total power [dBm]
PSCH Power [dBm]	P-SCH power [dBm]
SSCH Power [dBm]	S-SCH power [dBm]
Code Power [dBm]	Code power for each channel at the detected spreading factor, and Channelization code at the detected spreading factor @ spreading factor

■ Symbol Rate: Other than Composite

Header	Content
Measurement	Code domain power
Date Time	Date and time
Timeslot Index	Time slot serial number in the analysis range
Timeslot No.	Time slot number in the radio frame (0 to 14)
Total Power [dBm]	Total power [dBm]
PSCH Power [dBm]	P-SCH power [dBm]
SSCH Power [dBm]	S-SCH power [dBm]
Code Power [dBm]	Code power for each channel at the specified spreading factor

Code domain power versus Symbol.

Header	Content
Measurement	CDP vs Symbol
Date Time	Date and time of the waveform acquisition
Channelization Code No. @SF256	Channelization code at the spreading factor of 256
Timeslot Index	Time slot serial number in the analysis range
Timeslot No.	Time slot number in the radio frame (0 to 14)
Channelization Code No.	Channelization code at the detected or specified spreading factor @ spreading factor
Total Power [dBm]	Total power [dBm]
Symbol Power [dBm]	Power for each symbol [dBm]

Symbol EVM. The saved file format depends on the setting of Measurement Content in the Save menu.

Measurement Content: Other than All

Header	Content
Measurement	Symbol EVM
Date Time	Date and time of the waveform acquisition
Channelization Code No. @SF256	Channelization code at the spreading factor of 256
Timeslot Index	Time slot serial number in the analysis range
Timeslot No.	Time slot number in the radio frame (0 to 14)
Channelization Code No.	Channelization code at the detected or specified spreading factor @ spreading factor
Symbol EVM [%] or Symbol Mag Error [%] or Symbol Phase Error [deg]	Symbol EVM [%], mag error [%], or phase error [degrees] ¹ depending on the selection in Measurement Content.

¹ You can select the unit of phase by pressing **SYSTEM** → **Instrument Setup** → **Angular Units**.

Measurement Content: All

Header	Content
Measurement	Symbol EVM
Date Time	Date and time of the waveform acquisition
Channelization Code No. @SF256	Channelization code at the spreading factor of 256
Timeslot Index	Time slot serial number in the analysis range
Timeslot No.	Time slot number in the radio frame (0 to 14)
Channelization Code No.	Channelization code at the detected or specified spreading factor @ spreading factor
Symbol EVM [%]	Symbol EVM [%]
Symbol Mag Error [%]	Mag error [%]
Symbol Phase Error [deg]	Phase error [degrees] ¹

¹ You can select the unit of phase by pressing **SYSTEM** → **Instrument Setup** → **Angular Units**.

Symbol Table.

Header	Content
Measurement	Symbol EVM
Date Time	Date and time of the waveform acquisition
Channelization Code No. @SF256	Channelization code at the spreading factor of 256
Timeslot Index	Time slot serial number in the analysis range
Timeslot No.	Time slot number in the radio frame (0 to 14)
Channelization Code No.	Channelization code at the detected or specified spreading factor @ spreading factor
Modulation Type	QPSK or 16QAM
Symbol Value	Symbol value: 0 to 3 (QPSK) / 0 to 15 (16QAM). No rotation.

Modulation Accuracy.

Header	Content
Measurement	Modulation Accuracy
Date Time	Date and time of the waveform acquisition
Timeslot Index	Time slot serial number in the analysis range
Timeslot No.	Time slot number in the radio frame (0 to 14)
EVM (rms) [%]	RMS EVM [%]
EVM (peak) [%]	Peak EVM [%]
Mag Error (rms) [%]	RMS magnitude error [%]
Mag Error (peak) [%]	Peak magnitude error [%]
Phase Error (rms) [deg]	RMS phase error [deg] ¹
Phase Error (peak) [deg]	Peak phase error [deg] ¹
PCDE [dB]	PCDE (Peak Code Domain Error) [dB]
PCDE (Active) [dB]	PCDE for active channels only [dB]
Rho	Waveform quality
Frequency Error [Hz]	Frequency error [Hz]
Origin Offset [dB]	Origin offset [dB]
SSCH, SCG, SCN, AGS, AGV, RG, ACK	Time slot table for the items selected by VIEW: DEFINE → Column Items to Display

¹ You can select the unit of phase by pressing SYSTEM → Instrument Setup → Angular Units.

Uplink This subsection shows the saved file format for the uplink measurements.

Code Domain Power. The saved file format depends on the settings of View Format and Symbol Rate in the View Define menu.

■ View Format: Channel

Header	Content
Measurement	Code domain power
Date Time	Date and time of the waveform acquisition
Spreading Factor	Composite, or 2 to 256
Timeslot Index	Time slot serial number in the analysis range
Timeslot No.	Time slot number in the radio frame (0 to 14)
Total Power [dBm]	Total power [dBm]
Total Power (Offset) [dBm]	Offset total power for HS-DPCCH [dBm]
DPCCH Power (Offset) [dBm]	Offset DPCCH power for HS-DPCCH [dBm]
Code Power [dBm]	Code power for each channel (0 to 12) [dBm]

■ View Format: I/Q Split, Symbol Rate: Composite

Header	Content
Measurement	Code domain power
Date Time	Date and time of the waveform acquisition
Spreading Factor	Composite, or 2 to 256
Timeslot Index	Time slot serial number in the analysis range
Timeslot No.	Time slot number in the radio frame (0 to 14)
Total Power [dBm]	Total power [dBm]
Total Power (Offset) [dBm]	Offset total power for HS-DPCCH [dBm]
DPCCH Power (Offset) [dBm]	Offset DPCCH power for HS-DPCCH [dBm]
Code Power [dBm]	Code power for each channel at the detected spreading factor [dBm] Channelization code at the detected spreading factor @ spreading factor

■ Symbol Rate: Other than Composite

Header	Content
Measurement	Code domain power
Date Time	Date and time of the waveform acquisition
Spreading Factor	Composite, or 2 to 256
Timeslot Index	Time slot serial number in the analysis range
Timeslot No.	Time slot number in the radio frame (0 to 14)
Total Power [dBm]	Total power [dBm]
Total Power (Offset) [dBm]	Offset total power for HS-DPCCH [dBm]
DPCCH Power (Offset) [dBm]	Offset DPCCH power for HS-DPCCH [dBm]
Code Power [dBm]	
I	Code power for each channel on the I branch at the specified spreading factor [dBm]
Q	Code power for each channel on the Q branch at the specified spreading factor [dBm]

Code Domain Power versus Symbol. The saved file format depends on the settings of View Format in the View Define menu.

■ View Format: Channel

Header	Content
Measurement	CDP vs Symbol
Date Time	Date and time of the waveform acquisition
Channel No.	Channel number
Channel Name	Channel name
Timeslot Index	Time slot serial number in the analysis range
Timeslot No.	Time slot number in the radio frame (0 to 14)
Channelization Code No.	Channelization code at the detected or specified spreading factor @ spreading factor
I/Q Branch	I or Q (determined by channel)
Total Power [dBm]	Total power [dBm]
DPCCH Power [dBm]	DPCCH power [dBm]
Symbol Power [dBm]	Power for each symbol [dBm]

■ View Format: I/Q Split

Header	Content
Measurement	CDP vs Symbol
Date Time	Date and time of the waveform acquisition
Channelization Code No. @SF256	Channelization code at the spreading factor of 256
I/Q Branch	I/Q Branch setting
Timeslot Index	Time slot serial number in the analysis range
Timeslot No.	Time slot number in the radio frame (0 to 14)
Channel Name	Channel name (blank if the channel has no name or I/Q Branch is set to I/Q)
Channelization Code No.	Channelization code at the detected or specified spreading factor @ spreading factor
Total Power [dBm]	Total power [dBm]
DPCCH Power [dBm]	DPCCH power [dBm]
Symbol Power [dBm]	Power for each symbol [dBm]

Symbol EVM. The saved file format depends on the settings of View Format in the View Define menu.

■ View Format: Channel

Header	Content
Measurement	Symbol EVM
Date Time	Date and time of the waveform acquisition
Channel No.	Channel number
Channel Name	Channel name
Timeslot Index	Time slot serial number in the analysis range
Timeslot No.	Time slot number in the radio frame (0 to 14)
Channelization Code No.	Channelization code at the detected or specified spreading factor @ spreading factor
I/Q Branch	I or Q (determined by channel)
Symbol EVM [%] or Symbol Mag Error [%] or Symbol Phase Error [deg]	Symbol EVM [%], mag error [%], or phase error [degrees] ¹ depending on the selection in the VIEW: SCALE → Measurement Content.

¹ You can select the unit of phase by pressing **SYSTEM** → **Instrument Setup** → **Angular Units**.

■ View Format: I/Q Split

Header	Content
Measurement	Symbol EVM
Date Time	Date and time of the waveform acquisition
Channelization Code No. @SF256	Channelization code at the spreading factor of 256
I/Q Branch	I/Q Branch setting
Timeslot Index	Time slot serial number in the analysis range
Timeslot No.	Time slot number in the radio frame (0 to 14)
Channel Name	Channel name (blank if the channel has no name or I/Q Branch is set to I/Q)
Channelization Code No.	Channelization code at the detected or specified spreading factor @ spreading factor
I/Q Branch	I or Q (determined by channel)
Symbol EVM [%] or Symbol Mag Error [%] or Symbol Phase Error [deg]	Symbol EVM [%], mag error [%], or phase error [degrees] ¹ depending on the selection in the VIEW: SCALE → Measurement Content.

¹ You can select the unit of phase by pressing **SYSTEM** → **Instrument Setup** → **Angular Units**.

Symbol Table. The saved file format depends on the settings of View Format in the View Define menu.

■ View Format: Channel

Header	Content
Measurement	Symbol EVM
Date Time	Date and time of the waveform acquisition
Channel No.	Channel number
Channel Name	Channel name
Timeslot Index	Time slot serial number in the analysis range
Timeslot No.	Time slot number in the radio frame (0 to 14)
Channelization Code No.	Channelization code at the detected or specified spreading factor @ spreading factor
I/Q Branch	I or Q (determined by channel)
Symbol Value	Symbol value: 0 , 1, or X. No rotation.

■ View Format: I/Q Split

Header	Content
Measurement	Symbol EVM
Date Time	Date and time of the waveform acquisition
Channelization Code No. @SF256	Channelization code at the spreading factor of 256
I/Q Branch	I/Q Branch setting
Timeslot Index	Time slot serial number in the analysis range
Timeslot No.	Time slot number in the radio frame (0 to 14)
Channel Name	Channel name (blank if the channel has no name or I/Q Branch is set to I/Q)
Channelization Code No.	Channelization code at the detected or specified spreading factor @ spreading factor
Symbol Value	Symbol value: 0 , 1, or X. No rotation.

Modulation Accuracy.

Header	Content
Measurement	Modulation Accuracy
Date Time	Date and time of the waveform acquisition
Timeslot Index	Time slot serial number in the analysis range
Timeslot No.	Time slot number in the radio frame (0 to 14)
EVM (rms) [%]	RMS EVM [%]
EVM (peak) [%]	Peak EVM [%]
Mag Error (rms) [%]	RMS magnitude error [%]
Mag Error (peak) [%]	Peak magnitude error [%]
Phase Error (rms) [deg]	RMS phase error [deg] ¹
Phase Error (peak) [deg]	Peak phase error [deg] ¹
PCDE [dB]	PCDE (Peak Code Domain Error) [dB]
PCDE (Active) [dB]	PCDE for active channels only [dB]
Rho	Waveform quality
Frequency Error [Hz]	Frequency error [Hz]
Origin Offset [dB]	Origin offset [dB]
SIG, PRE, TPC, TFCI, ACK, CQI, Offset, RSN, E-TFCI, Happy	Time slot table for the items selected by VIEW: DEFINE → Column Items to Display

¹ You can select the unit of phase by pressing **SYSTEM** → **Instrument Setup** → **Angular Units**.

Appendix C: Factory Default Settings

This section provides tables of the GPIB command default settings. The *RST command returns the instrument settings to the factory defaults for the measurement mode specified with :INSTRUMENT[:SELEct], as shown in the following tables. The column to the far right shows the measurement modes in which the command is available.

Table C-1: Factory initialization settings, :DISPlay commands

Header	Default value
:DISPlay:DLR6_3GPP subgroup	
:DISPlay:DLR6_3GPP:AVIew:CCODE	0
:DISPlay:DLR6_3GPP:AVIew:MSLot[:STATE]	OFF
:DISPlay:DLR6_3GPP:AVIew:RESult:AGSCOpe	OFF
:DISPlay:DLR6_3GPP:AVIew:RESult:AGValue	OFF
:DISPlay:DLR6_3GPP:AVIew:RESult:ANACK	OFF
:DISPlay:DLR6_3GPP:AVIew:RESult:RGRant	OFF
:DISPlay:DLR6_3GPP:AVIew:RESult:SCGRoup	ON
:DISPlay:DLR6_3GPP:AVIew:RESult:SCNumber	ON
:DISPlay:DLR6_3GPP:AVIew:RESult:SSCH	ON
:DISPlay:DLR6_3GPP:AVIew:SRATe	COMPOSITE
:DISPlay:DLR6_3GPP:AVIew:SSCHpart	OFF
:DISPlay:DLR6_3GPP:AVIew:TSLot	0
:DISPlay:DLR6_3GPP:MVIew:FORMat	OFF
:DISPlay:DLR6_3GPP:MVIew :SVIew:RADIx	BINARY
:DISPlay:DLR6_3GPP:MVIew :SVIew:Y[:SCALE]:PUNit	RELATIVE
:DISPlay:ULR6_3GPP:MVIew:FORMat	OFF
:DISPlay:ULR6_3GPP subgroup	
:DISPlay:ULR6_3GPP:AVIew:CCODE	0
:DISPlay:ULR6_3GPP:AVIew:CNUMBER	0
:DISPlay:ULR6_3GPP:AVIew:FORMat	CHANNEL
:DISPlay:ULR6_3GPP:AVIew:IQRanch	BOTH
:DISPlay:ULR6_3GPP:AVIew:RESult:ANACK	OFF
:DISPlay:ULR6_3GPP:AVIew:RESult:CQI	OFF
:DISPlay:ULR6_3GPP:AVIew:RESult:ETFCi	OFF
:DISPlay:ULR6_3GPP:AVIew:RESult:HAPPY	OFF
:DISPlay:ULR6_3GPP:AVIew:RESult:OFFSet	OFF
:DISPlay:ULR6_3GPP:AVIew:RESult:PREamble	ON
:DISPlay:ULR6_3GPP:AVIew:RESult:RSN	OFF
:DISPlay:ULR6_3GPP:AVIew:RESult:SIGNature	ON
:DISPlay:ULR6_3GPP:AVIew:RESult:TFCI	OFF
:DISPlay:ULR6_3GPP:AVIew:RESult:TPC	OFF

Table C-1: Factory initialization settings, :DISPlay commands

Header	Default value
:DISPlay:ULR6_3GPP:AVIew:SRATe	COMPOSITE
:DISPlay:ULR6_3GPP:AVIew:TSLot	0
:DISPlay:ULR6_3GPP:MVIew:FORMat	OFF
:DISPlay:ULR6_3GPP:MVIew :SVIew:RADIx	BINary
:DISPlay:ULR6_3GPP:MVIew :SVIew:Y[:SCALe]:PUNit	RELative
:DISPlay:ULR6_3GPP:SVIew:FORMat	SPECtrum

Table C-2: Factory initialization settings, :SENSe commands

Header	Default value
[:SENSe]:DLR6_3GPP subgroup	
[:SENSe]:DLR6_3GPP:BLOCK	0
[:SENSe]:DLR6_3GPP:CARRier:OFFSet	0
[:SENSe]:DLR6_3GPP:CARRier:SEARCh	ON
[:SENSe]:DLR6_3GPP:CCODE:EACh	0
[:SENSe]:DLR6_3GPP:CCODE:ERCh	0
[:SENSe]:DLR6_3GPP:COMPOSITE	ON
[:SENSe]:DLR6_3GPP:DTYPe:SEARCh	ON
[:SENSe]:DLR6_3GPP:EVM:IQOffset	ON
[:SENSe]:DLR6_3GPP:FILTer:ALPHA	0.22
[:SENSe]:DLR6_3GPP:FILTer:MEASurement	RRCosine
[:SENSe]:DLR6_3GPP:FILTer:REFerence	RCOSine
[:SENSe]:DLR6_3GPP:LENGth	512000
[:SENSe]:DLR6_3GPP:OFFSet	0
[:SENSe]:DLR6_3GPP:SCHPart	OFF
[:SENSe]:DLR6_3GPP:SCODE:ALTerNative	NUSed
[:SENSe]:DLR6_3GPP:SCODE:NUMBER	0
[:SENSe]:DLR6_3GPP:SCODE:SEARCh	OFF
[:SENSe]:DLR6_3GPP:CCODE:EACh	0
[:SENSe]:DLR6_3GPP:CCODE:ERCh	0
[:SENSe]:ULR6_3GPP subgroup	
[:SENSe]:ULR6_3GPP:BLOCK	0
[:SENSe]:ULR6_3GPP:CARRier:OFFSet	0
[:SENSe]:ULR6_3GPP:CARRier:SEARCh	ON
[:SENSe]:ULR6_3GPP:CCONfig	AUTO
[:SENSe]:ULR6_3GPP:DFOrmat	AUTO
[:SENSe]:ULR6_3GPP:EVM:IQOffset	ON
[:SENSe]:ULR6_3GPP:EVM:TPERiods	EXclude
[:SENSe]:ULR6_3GPP:FILTer:ALPHA	0.22
[:SENSe]:ULR6_3GPP:FILTer:MEASurement	RRCosine
[:SENSe]:ULR6_3GPP:FILTer:REFerence	RCOSine
[:SENSe]:ULR6_3GPP:LENGth	512000

Table C-2: Factory initialization settings, :SENSe commands

Header	Default value
[:SENSe]:ULR6_3GPP:MMODE	DPCH
[:SENSe]:ULR6_3GPP:OFFSet	0
[:SENSe]:ULR6_3GPP:SCODE:NUMBer	0
[:SENSe]:ULR6_3GPP:SCODE:TYPE	LONG
[:SENSe]:ULR6_3GPP:SFRame:OFFSet:DTIME	1
[:SENSe]:ULR6_3GPP:SFRame:OFFSet[:STSLot]	0
[:SENSe]:ULR6_3GPP:SFRame:SEARCh	DTIME
[:SENSe]:ULR6_3GPP:SFRame:TOLerance	0
[:SENSe]:ULR6_3GPP:THReshold[:BURSt]	-30 dB
[:SENSe]:ULR6_3GPP:THReshold:DTX	-11.8 dB



Glossary and Index

Glossary

Acronyms

3GPP

3rd Generation Partnership Project

BPSK

Binary Phase Shift Keying

CDP

Code Domain Power

CPICH

Common Pilot Channel

CQI

Channel Quality Indicator

DCH

Dedicated Channel

DPCCH

Dedicated Physical Control Channel

DPDCH

Dedicated Physical Data Channel

DL

Down Link

DTX

Discontinuous Transmission

E-AGCH

E-DCH Absolute Grant Channel

E-DCH

Enhanced Dedicated Channel

E-DPCCH

Enhanced Dedicated Physical Control Channel

E-DPDCH

Enhanced Dedicated Physical Data Channel

E-HICH

E-DCH HARQ ACK Indicator Channel

E-RGCH

E-DCH Relative Grant Channel

E-TFC

E-DCH Transport Format Combination

EVM

Error Vector Magnitude

HARQ

Hybrid Automatic Repeat Request

HSDPA

High Speed Downlink Packet Access

HS-DPCCH

Dedicated Physical Control Channel for HS-DSCH

HS-DSCH

High-Speed Downlink Shared Channel

PCDE

Peak Code Domain Error

PRACH

Physical Random Access Data Channel

PCPCH

Physical Common Packet Channel

P-SCH

Primary Synchronization Channel

QAM

Quadrature Amplitude Modulation

QPSK

Quadrature Phase Shift Keying

RLS

Radio Link Set

RSN

Retransmission Sequence Number

SCG

Scrambling Code Group

SCH

Synchronization Channel
(consisting of Primary and Secondary synchronization channels)

SCN

Scrambling Code Number

S-SCH

Secondary Synchronization Channel

STTD

Space Time block coding based Transmit antenna Diversity

TFC

Transport Format Combination

TFCI

Transport Format Combination Indicator

TPC

Transmit Power Control

TS

Time Slot

UL

Up Link

Index

A

Additional functions in Option 27, 1-1

C

Changing the view

Downlink analysis in the Demod mode, 2-40

downlink analysis in the Demod mode, 2-9

Code domain power

downlink, 2-12

uplink, 2-44

Code power versus Symbol

downlink, 2-18

uplink, 2-50

Code power versus Time slot

downlink, 2-16

uplink, 2-48

Command groups, 3-1

:CONFigure commands, 3-7

CQI, 1-4

D

Default settings, C-1

Definition

Downlink analysis, 1-2

Uplink analysis, 1-3

:DISPlay Commands, 3-9

Downlink analysis

Demod mode, 2-1

Meas Setup menu, 2-5

measurement procedure, 2-2

Downlink time offset, 2-35

DTO, 2-34

DTX, 1-4

F

Factory default settings, C-1

:FETCh commands, 3-55

G

Gain ratio

uplink, 2-61

M

Meas Setup menu

downlink analysis in the Demod mode, 2-5

uplink analysis, 2-32

Measurement procedure

downlink analysis, 2-2

uplink analysis, 2-30

:MMEMory commands, 3-69

Modulation accuracy

downlink, 2-25

uplink, 2-57

Modulation accuracy versus Time slot

downlink, 2-26

uplink, 2-59

O

Offset

downlink time, 2-35

subframe to time slot, 2-34

P

Power codogram

downlink, 2-14

uplink, 2-46

R

Range, scale setting, A-1, B-1

Related manuals, v

S

Save format, B-2

Scale setting range, A-1, B-1

:SENSe commands, 3-77

Setting range, scale, B-1

STO, 2-34

Subframe to TS offset, 2-34

Symbol constellation

downlink, 2-20

uplink, 2-52

Symbol EVM

downlink, 2-21

uplink, 2-53

Symbol eye diagram

downlink, 2-23

uplink, 2-55

Symbol table
 downlink, 2-24
 uplink, 2-56

U

Uplink analysis
 Demod mode, 2-29
 measurement procedure, 2-30

V

View
 downlink analysis, 2-8
 uplink analysis, 2-39